



Department of Planning and Environment

planning.nsw.gov.au

Guide to Complying Development

August 2023



Acknowledgement of Country

The Department of Planning and Environment acknowledges that it stands on Aboriginal land. We acknowledge the Traditional Custodians of the land and we show our respect for Elders past, present and emerging through thoughtful and collaborative approaches to our work, seeking to demonstrate our ongoing commitment to providing places in which Aboriginal people are included socially, culturally and economically.

Published by NSW Department of Planning and Environment

dpie.nsw.gov.au

GUIDE TO COMPLYING DEVELOPMENT

First published: August 2022

Revised: August 2023

IRDDepartment reference number: IRD22/9357

More information

For further information email: codes@planning.nsw.gov.au

Copyright and disclaimer

© State of New South Wales through Department of Planning and Environment 2022. Information contained in this publication is based on knowledge and understanding at the time of writing, July 2022, and is subject to change. For more information, please visit

dpie.nsw.gov.au/copyright

Cover Image: Jacaranda
Architect: Panov Scott
Photographer: Brett Bo
page: DPE



Riverview House, Architect: David Boyle Architect
Photographer: Brett Boardman

Contents

Introduction

Purpose of the Guide	1
Who is this Guide for?	1
What is exempt and complying development?	2
How to use this Guide	5
Other important information	6

Steps to development

6 steps to complying development	8
----------------------------------	---

Step 1

Determine if your development is exempt development	1-1
---	-----

Step 2

Getting started with complying development	2-1
Is complying development permissible on your land?	2-3

Step 3

Which code applies?	3-1
The Code books.	4
Part 3 Housing Code	3:3-01
Part 3A Rural Housing Code	3:3A-01
Part 3B Low Rise Housing Diversity Code	3:3B-01
Part 3C Greenfield Housing Code	3:3C-01
Part 3D Inland Housing Code	3:3D-01
Part 4 Housing Alterations Code	3:4-01

Step 4

How to apply the Codes	3-2
------------------------	-----

Step 5

Conditions and other requirements for complying development	4-1
---	-----

Step 6

Submit a complying development application	5-1
--	-----

Appendices

Required documents	A-1
Acronyms and Abbreviations	A-6
Photo credits	A-7
Glossary of terms	A-8

Introduction



Purpose of the Guide

It is possible to carry out a range of building projects without having to lodge a development application (DA) using the state wide exempt and complying development codes.

Some projects do not require any approvals (exempt) and some may need approvals.

The Guide will outline whether exempt or complying development is applicable or possible for your project.

Projects that may be undertaken include new housing, renovations to houses, commercial and industrial projects, and a range of smaller projects like swimming pools and fences.

This Guide aims to provide an easy to follow document written in plain language, that helps to determine if you can carry out your development as exempt or complying development, or whether you need to lodge a development application (DA).

This Guide will also assist in preparing an application for a complying development certificate (CDC) for residential projects by outlining the steps involved and providing guidance on the applicable development standards.

Who is this Guide for?

Homeowners and developers can use this Guide to understand the legislative requirements for developing small scale residential projects, for example, building a new one or two storey home or home renovation.

This Guide also provides guidance for industry professionals including architects, certifiers, local councils, designers and others to assist in the design and assessment of complying development applications.

What is exempt and complying development?

Exempt and complying development is certain specified development, on certain land, that meets a set of pre-defined design standards. In meeting these criteria, the development is eligible for a fast-tracked approvals process.

The relevant legislation governing exempt and complying development is the State Environmental Planning Policy (Exempt and Complying Codes) 2008 (also referred to as the “Codes SEPP”).

Exempt development

For small scale or minor building works, there may be no need to obtain any formal development approval.

Exempt development broadly covers small scale and minor building works, such as fences, air-conditioning units, minor building alterations, water tanks and the like.

Provided all criteria set out in the Codes SEPP for exempt development are met, exempt development does not need approval to carry out.

It is important to recognise exempt development must satisfy all applicable development standards and the deemed-to-satisfy building provisions of the National Construction Code. If it does not, then it is no longer exempt development and another approval pathway must be used (eg. complying development or DA).

Complying development

Complying development is a fast-track approval process for straight forward residential, commercial and industrial development.

Complying development generally includes larger building works than exempt development. If the proposal meets specific development standards, it can be assessed and determined by a council or a registered certifier without the need for a full DA.

The Codes SEPP contains provisions for a range of development types that qualify for complying development. While this Guide is concerned with residential uses, the Codes SEPP also includes provisions for commercial and industrial projects, subdivisions (strata and Torrens), fire safety systems, and demolition.

Examples of residential complying development include:

- new houses up to two storeys
- renovating an existing house
- ‘diverse housing types’ housing (dual occupancies, terraces, manor houses)
- a new swimming pool

The Codes SEPP has separate parts for different types of development. Each has its own set of specific development controls that must be complied with.

Depending on the type of residential project being proposed, and the location of the project (e.g. located in a rural local council area) different development standards will apply. Step 3 of this Guide will assist in selecting the correct Part applicable for your project.

Examples of complying development

Image credits in appendices

NEW DWELLING HOUSE



INTERNAL ALTERATIONS



REAR ADDITION



NEW DWELLING HOUSE



EXTERNAL ALTERATIONS



NEW DWELLING HOUSE



REAR ADDITIONS



INTERNAL ALTERATIONS



SWIMMING POOLS

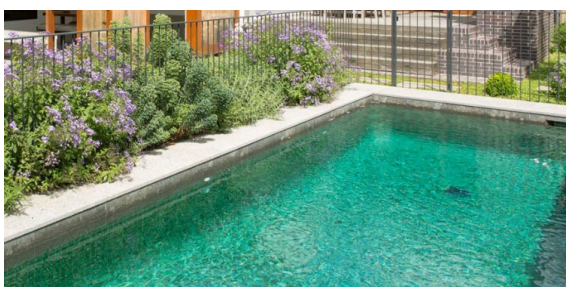

REAR ADDITIONS



Who can assess and approve complying development?

An application for a CDC will be lodged with the certifying authority. Unlike a DA, the certifying authority can be your local council or a registered certifier.

The NSW Department of Fair Trading maintains an [online portal](#) for finding and appointing a certifier.

It is recommended that you start talking to a certifier (council or a registered certifier) before you start finalising your plans.

They can provide guidance to ensure that your project meets the relevant requirements and development standards.

Once a CDC has been approved, and before any construction commences, a principal certifier (PC) must be appointed to assess and inspect the construction works and certify that they have been carried out in accordance with the approved CDC and all relevant codes.

The certifying authority that assessed the CDC may be appointed as the PC, or a new PC may be appointed.

Finding and Appointing a Certifier

Background

Under the NSW planning system, a development consent is required in most instances. There are generally three pathways for development:

- **exempt development**, covers certain types of minor work where no application for planning or construction approval is required, however, there are standards which must be met
- **complying development**, covers work that meets certain pre-determined development standards and can be assessed and carried out by a certifying authority (council or private accredited certifier), in 20 days or
- **merit based assessment** which requires a DA to be submitted to a consent authority (usually council) for assessment and results in a development consent, if approved.

The NSW Government is streamlining the development approval processes for low impact and routine development proposals, freeing up the merit based system for more complex and sensitive developments.

The principal aim of the Codes SEPP is to remove unnecessary complexity and red tape for home owners constructing single or two storey dwelling houses or embarking on low impact renovations or improvements to their homes.

Images previous page: (left to right, top to bottom)

Project	Architect	Photographer
Riverview House	David Boyle Architect	Brett Boardman
Pompei	Carter Williamson	Katherine Lu
Mosman Minka	Downie North	Katherine Lu
Putney Hill	Cox for Frasers Property Australia	Martin Mischkulnig
Day House	Allied Office	Tom Ferguson
Kingsford House	GSBN Studio	GSBN Studio
Allen Key House	Studio Prineas	Chris Warnes
Hole in the Roof House	Neeson Murcutt + Neille	Brett Boardman
Denney House	Sam Crawford Architects	Brett Boardman
Gipps Street House	Scale Architecture	Scale Architecture

How to use this Guide

The Guide includes a logical step by step process for determining if your residential project can be carried out under the Codes SEPP, and, if it is eligible, the specific standards and criteria that must be met.

The steps to prepare an application using this Guide are as follows:

Step 1 Determine if your project is exempt development

Step 2 Confirm if complying development is permissible on your land

Step 3 Determine what type of residential development you are proposing

Step 4 Confirm if your project meets the relevant development standards

Step 5 Confirm your project meets all other requirements

Step 6 Lodge a complying development certificate application

It is important to follow each step in the Guide. There is critical information in multiple parts of the Codes SEPP, and some may be easy to miss.

Depending on the location of the land, various environmental factors, and pre-existing conditions, complying development may not be permissible even if it meets all other controls.

By following the steps in this Guide carefully, you will be able to determine if exempt or complying development are appropriate for your project.

This Guide contains hyperlinks under each heading that will direct you to the relevant clauses in the Codes SEPP.

Other important information

This Guide has been prepared as a supporting document for the Codes SEPP. It does not replace the Codes SEPP, and in all instances, if there is a discrepancy between the Guide and the Codes SEPP, the Codes SEPP takes precedence.

Complying development not covered by this Guide

There are many different types of development covered by the Codes SEPP, as well as under other SEPPs.

The following parts of the Codes SEPP are excluded from this Guide:

- Part 4A General Development
- Part 5 Industrial and Business Alterations Code
- Part 5A Industrial and Business Buildings Code
- Part 6 Subdivisions
- Part 7 Demolition
- Part 8 Fire Safety

Other forms of residential development are able to be considered for complying development, but are not covered by the Codes SEPP, or this Guide.

For example, the State Environmental Planning Policy (Affordable Rental Housing) 2021 includes complying development controls for:

- infill affordable housing
- secondary dwellings
- boarding houses
- residential flat buildings social housing providers, public authorities and joint ventures
- build to rent housing
- group homes

Note: secondary dwellings (sometimes referred to as 'granny flats') can be complying development. However, the controls for these are covered under State Environmental Planning Policy (Housing) 2021.

Home-based childcare may be exempt or complying development but are assessed under the State Environmental Planning Policy (Transport and Infrastructure) 2021.

Other relevant documentation and literature

When preparing the design and documentation for your complying development application, it may also be necessary to consider other legislation that regulates exempt and complying development including:

- [Environmental Planning and Assessment Act 1979](#) (EP&A Act 1979)
- [Environmental Planning and Assessment Regulation 2021](#) (EP&A Regulation 2021)
- [Local Government Act 1993](#)
- The local council Local Environmental Plan (LEP)
- [National Construction Code, Building Code of Australia](#) (BCA)
- [Australian Standards](#) (AS)
- [Roads Act 1993](#)
- [Swimming Pools Act 1992](#)
- [National Park and Wildlife Act 1974](#)
- [Conveyancing Act 1919](#)
- [Protection of the Environment Operations Act 1991](#)
- [Work Health and Safety Act 2011](#)
- [Threatened Species Conservation Act 1995](#)

What documentation is required for a CDC?

A detailed checklist of documents that must be included in the application is available on the NSW Planning Portal website. Make sure all items required have been completed prior to lodging the application.

All applications for complying development are now lodged through the NSW Planning Portal.

Steps to development

A step by step guide to completing your exempt
or complying development application



6 steps to complying development

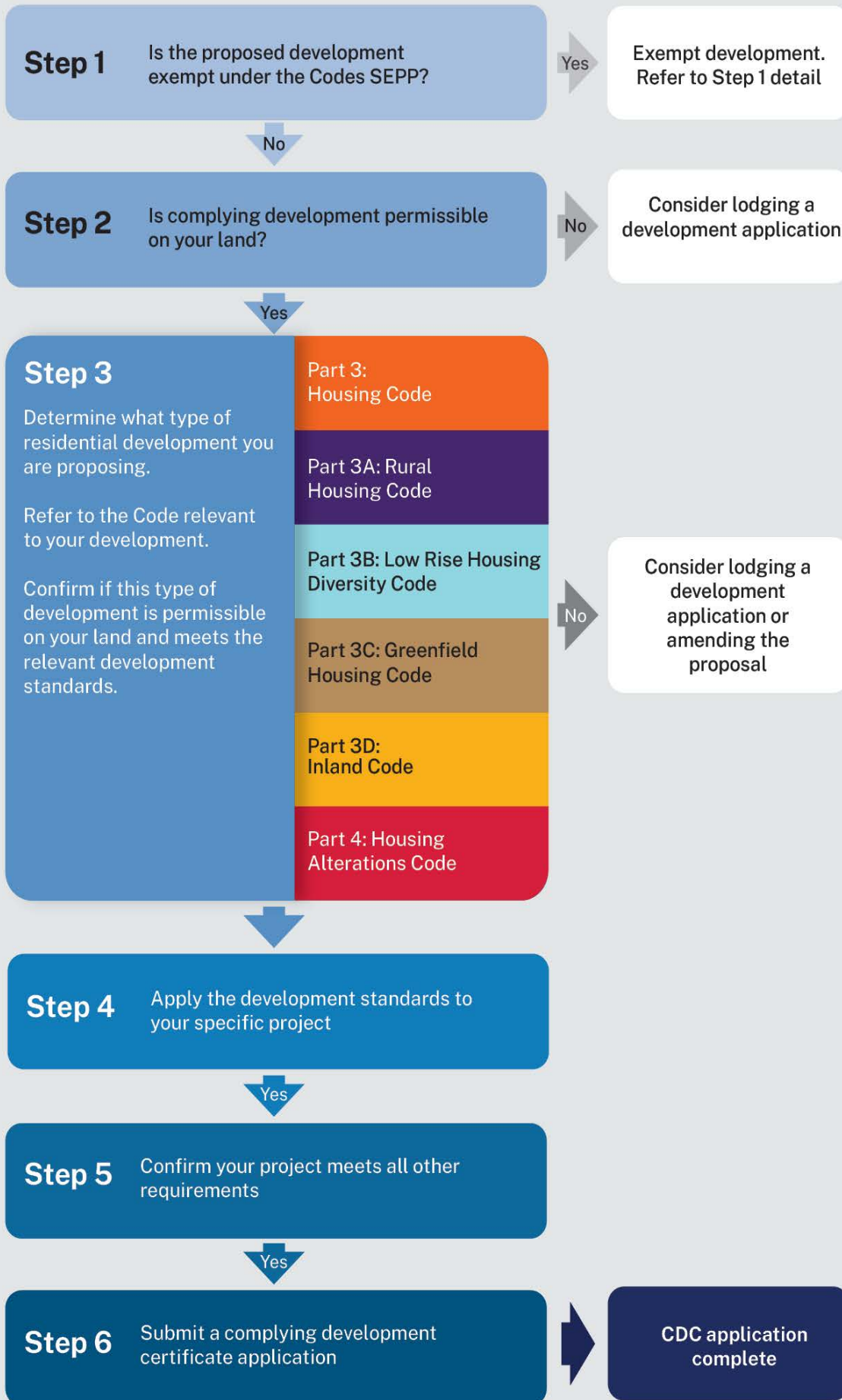

Step 1

Determine if your project is exempt development



Determine if your development is exempt development

Step 1.1 - Is the proposed development exempt under the Codes SEPP?

[Codes SEPP Part 2 Division 1 General Exempt Development Code](#)

Examples of exempt development under the General Exempt Development Code that may be applicable to homeowners include, but are not limited, to:

- Aerials, antennae and communication dishes
- Air-conditioning units
- Aviaries
- Awnings, blinds and canopies
- Balconies, decks, patios, pergolas, terraces and verandahs
- Barbecues and other outdoor cooking structures
- Cabanas, cubby houses, ferneries, garden sheds, gazebos and greenhouses
- Carports
- Clothes hoists and clothes lines
- Demolition
- Driveways and hard stand spaces
- Earthworks, retaining walls and structural support
- Emergency work and repairs
- Evaporative cooling units (roof mounted)
- Fences (certain zones)
- Fences for swimming pools (certain zones)
- Flagpoles
- Garbage bin storage enclosure
- Home businesses, home industries and home occupations
- Hot water systems
- Landscaping structures
- Letterboxes
- Maintenance of buildings in draft heritage conservation areas
- Minor building alterations (internal)
- Minor building alterations (external)
- Pathways and paving
- Playground equipment
- Portable swimming pools and spas and child-resistant barriers
- Privacy screens
- Rainwater tanks (above ground)
- Rainwater tanks (below ground)
- Roller shutter doors adjoining lanes
- Screen enclosures (of balconies, decks, patios, pergolas, terraces and verandahs)
- Shade structures of canvas, fabric, mesh or the like
- Skylights, roof windows and ventilators
- Stairway
- Street library
- Subdivision
- Sculptures and artworks
- Tennis courts
- Water features and ponds
- Waterway structures – minor alterations

Note: development controls for solar energy systems can be found in the [Transport and Infrastructure SEPP 2021](#)

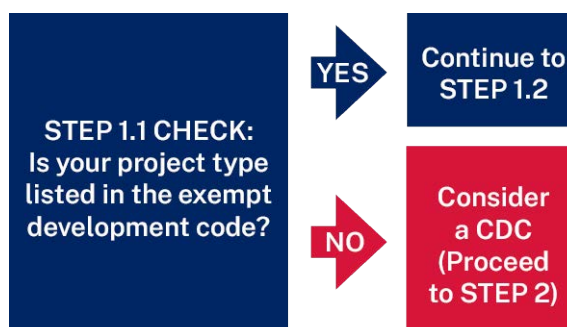

Step 1.2 - Does the proposed development meet the general requirements under the Codes SEPP?

[Clause 1.15](#) What development is exempt development?

[Clause 1.16](#) General requirements for exempt development

[Clause 1.16A](#) Exempt development on land within 18 kilometres of Siding Spring Observatory

Under the Codes SEPP, demolition of a heritage item, draft heritage item, in a heritage conservation area or a draft heritage conservation area is not permitted

In heritage conservation areas and draft heritage conservation areas, some exempt development types may be restricted to the rear yard only.

Confirm your proposed development meets **ALL** general requirements for exempt development.

[Schedule 2](#) Exempt development codes – variations

[Schedule 4](#) Land excluded from the General Exempt Development Code

Schedules 2 and 4 at the end of the Codes SEPP describe areas that are excluded from exempt development, as well as specific types of development that have been excluded from some areas.

Confirm your land or development type has not been excluded.



Step 1.3 - Does it meet the Exempt development standards under the Codes SEPP?

[Codes SEPP Part 2 Exempt Development Codes](#)

Refer to the specific exempt development type you are proposing. Confirm your proposed development is specified development, and complies with **ALL** development standards



Step 1.4 - Have all the conditions and other requirements been met ?

Confirm compliance with all other relevant requirements. These may include:

- The Building Code of Australia (BCA)
- Australian Standards
- Asbestos removal guidelines
- Tree preservation orders

Demolition and asbestos removal

For exempt development, a note has been included in the Codes SEPP to alert homeowners to the risks of asbestos and statutory requirements relating to its removal and disposal. The note will also guide people to seek additional information from the Government's website.

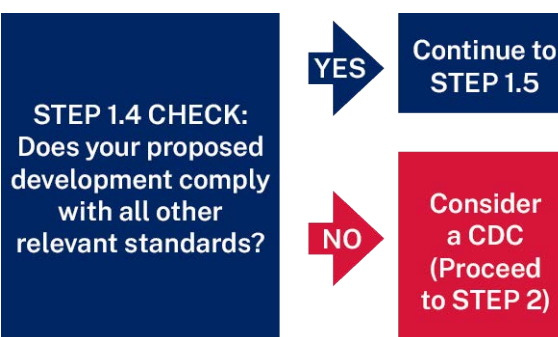

Step 1.5

If you meet all the requirements, you can proceed with your development without further planning approval

Part 2 Note 2 - A person may carry out development specified in this code without obtaining development consent from a consent authority if the person complies with the development standards that apply to the development (which includes the deemed-to-satisfy provisions of the Building Code of Australia).

Carry out the exempt development according to all codes, standards and guidelines.

Tip: Retain a record of your notes and details of the exempt development for future reference. If queries are raised or if the Codes SEPP changes this will be your proof of compliance with the Codes SEPP at the time the works were carried out.

Step 2

Determine if complying development is permissible on your land



Getting started with complying development

To help work out if your project is likely to be exempt, complying, or needing a development application, you should first obtain the following documents and follow the following steps.

Initial documents

Planning certificates

A planning certificate will answer many questions up front and save time in preparing your CDC application.

Local councils in NSW can issue planning certificates, which are legal documents that set out planning information for your property. This information includes how the property can be used, the planning instruments and legislation that applies, and any restrictions on development.

While the certificate will state all the relevant planning instruments that apply to the property, it does not identify the specific development standards or terms of the instruments.

There are two types of planning certificate available, depending on the amount of information you need:

- A section 10.7 (2) planning certificate provides planning information such as zoning, the relevant state, regional and local planning controls and other planning affectations including complying development.
- A section 10.7 (5) planning certificate provides additional information affecting the land where council has information available, such as sub division history, and easements where available.

You can contact your local council to obtain a planning certificate for your property. Note: fees will apply.

It is strongly recommended that a 10.7 planning certificate is obtained prior starting to streamline the initial steps in preparing your complying development application.

A planning certificate will answer many questions up front and save time in preparing your CDC application.

Certificate of title and survey plan

A certificate of title that indicates the size of the lot and any easements or notations that may affect the lot.

A certificate of title is available from [NSW Land Registry Services](#).

A survey plan prepared by a registered surveyor is also useful (and required for some CDCs). Make sure the surveyor includes the location of houses on adjoining lots, contours, trees, any easements, and plenty of existing ground levels around where you propose your new development as this will be useful in determining setbacks and building heights.

Planning portal mapping

The Planning Portal [ePlanning Spatial Viewer](#) is an interactive mapping service that provides detailed information on every lot within NSW. Much of the information required to complete Step 2 and Step 3 may be found on these maps.

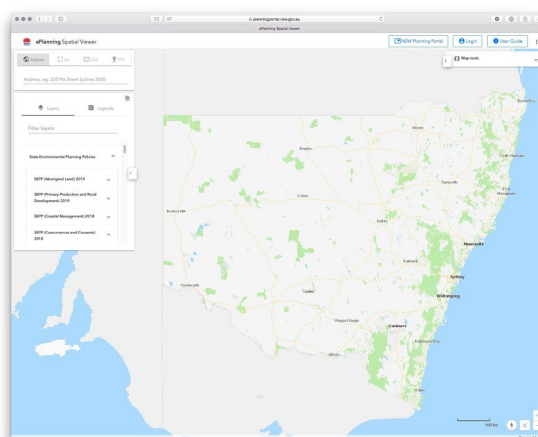

Note: the ePlanning Spatial viewer is a tool and users still need to check that the information is up to date and accurate.

please refer to the ePlanning Spatial Viewer's Terms and conditions of use

Appoint a certifying authority

The NSW Department of Fair Trading maintains an [online portal](#) for finding and appointing a certifier.

It is recommended that you start talking to your certifying authority (council or a registered certifier) before you start finalising your plans. They can provide guidance to ensure that you meet with the relevant requirements and development standards.

A PCA must be appointed prior to the commencement of any construction works.

Contact your local council

You may consider contacting your local council to discuss your proposed works and to ask any questions you may have. The local council planning staff will have an understanding of the specific issues of the area and be able to provide detailed feedback on your queries.

If the development is close to infrastructure facilities, such as power lines, check or contact the relevant service providers to confirm the development meets their safety requirements.

Other consultants

As an approved CDC grants permission to commence construction, the design and documentation must demonstrate compliance with the Building Code of

Australia (BCA) and all relevant Australian Standards.

Other consultants may need to be engaged to show compliance with the BCA and Standards, such as:

- Structural engineer
- Stormwater engineer
- Geotechnical engineer
- Surveyor
- Landscape Architect

Other approvals

Other additional consultants and authority approvals may be needed, including:

- Local council for:
 - driveway crossings
 - stormwater connections
 - water service (in regional areas)
 - septic tanks (in regional areas)
- Sydney Water for water and sewer in the Greater Sydney area.



Hole in the Roof House,
Architect: Neeson Murcutt + Neille
Photographer: Brett Boardman

Is complying development permissible on your land?

The requirements for complying development are set out in [Part 1](#) and [schedule 5](#) of the Codes SEPP. These requirements include that the development must:

- be permissible with consent in the land use zone in which it is proposed to be carried out
- meet the relevant provisions of the BCA
- meet the land based requirements
- not be land excluded under Schedule 5
- not be land excluded under clause 1.19
- not restricted by covenants under clause 1.20

In addition to this, if your land is located on bushfire prone land or a flood control lot, complying development may not be permissible

A section 10.7 planning certificate is strongly recommended for this step of the Guide.

The planning certificate will state whether complying development is possible on your site and which Code is applicable.

A planning certificate may be obtained through your local council.

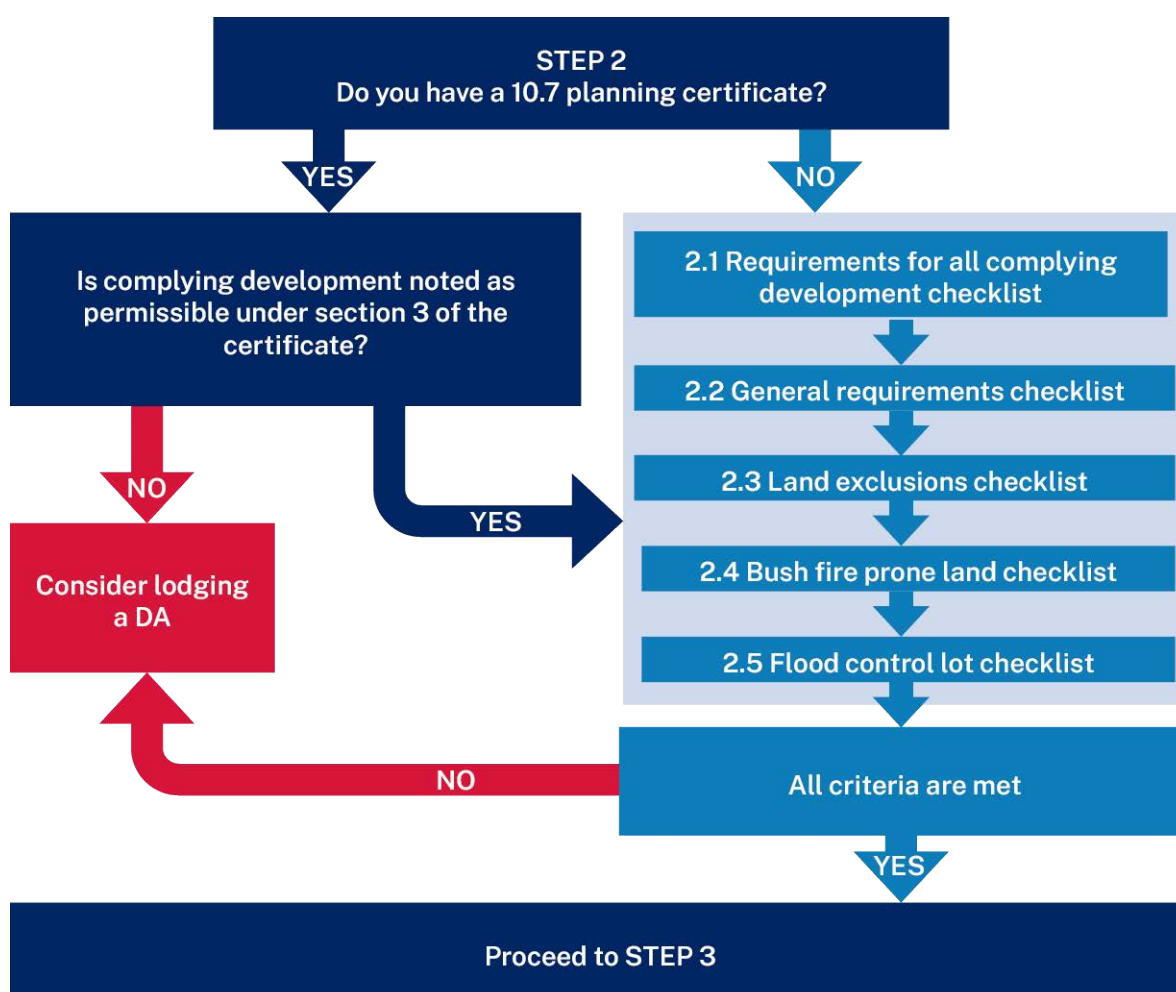

2.1 Requirements for complying development

Clause 1.17A

Clause 1.17A contains requirements for complying development for all environmental planning instruments. If you answer no to any of the clauses in the table below, complying development is not possible.

Clause	Criteria	Comment	Complies?		
			Y	N	n/a
1.17A					
1(a)	The development must not require the concurrence of a person other than the consent authority or the Director- General of the Department of Environment, Climate Change and Water.	Sometimes development needs additional approvals by other authorities. This is known as integrated development (refer to cl4.46 of the EP&A Act.) If you are unsure, contact your local council for confirmation.			
1(b)	Must not be on land that is a critical habitat	Refer to your 10.7 planning certificate, section 2, or Planning Portal Spatial Viewer			
1(c)	Must not be on land that is a wilderness area	If you are unsure, contact your local council for confirmation.			
1(d)	Must not: <ul style="list-style-type: none"> i. comprise or be located on an item listed on the State Heritage Register ii. be subject to interim heritage order iii. be identified as an item of environmental heritage or as a heritage item by an environmental planning instrument 	Refer to your 10.7 planning certificate, section 2, or Planning Portal Spatial Viewer. NSW Heritage maintains an inventory of heritage items . See the following clauses (2,3,4) for exceptions, and amendments to this clause.			
2	If the development has been granted an exemption under section 57(2) of the <i>Heritage Act 1977</i> or is subject to an exemption under section 57(1A) or (3) of that Act, it may be considered for complying development	Consult with council if you are unsure.			
3	If the development does not comprise the whole of the relevant land, (1)(d) only applies to the part of the land described and mapped on the register	Exemption to (1)(d) above if the development is not on the listed part of the land.			

4	If an item not listed on the State Heritage Register but identified as an item of environmental heritage in an environmental planning instrument does not comprise, or is not located on, the whole of the relevant land, (1)(d) applies only to the part of the land that is described and mapped on that instrument.	Exemption to (1)(d) above if the development is not on the listed part of the land.
---	--	---

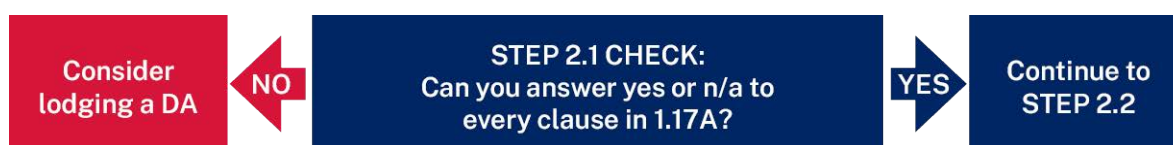

2.2 General requirements

Clause 1.18

Clause 1.18 contains the general requirements for complying development. If you answer no to any of the clauses in the table below, complying development is not possible.

Clause	Criteria	Comment	Complies?		
			Y	N	n/a
1.18					
1(a)	Must not be exempt development	See Step 1			
1(b)	Must be a permissible use on the site	Refer to your 10.7 planning certificate, section 2 for permissible and prohibited uses. For example, a CDC for alterations to an existing multi-dwelling building in an R2 zoning is not possible, as multi-dwelling uses are not a permissible use in that zone.			
1(c)	Meet the relevant provisions of the BCA	The proposed development will need to comply with the BCA. Double check prior to lodging application			
1(c1)	Must not require an Environmental Protection License	Environment protection licences			

Clause	Criteria	Comment	Complies?		
			Y	N	n/a
1.18					
1(c2)	Must not be designated development	Designated development is defined in schedule 3 of the EP&A Regulations . They are unlikely to apply to a residential project.			
1(c3)	Must not be on land that comprises, or on which there is a draft heritage item	Note: draft heritage items are the same as 'interim'. Refer to your 10.7 planning certificate, section 2, or Planning Portal Spatial Viewer. NSW Heritage maintains an inventory of heritage items .			
1(d)(i)	Must have an approval for an on-site effluent disposal system (if the site is unsewered)	If the existing site does not have a sewer system, one will need to be installed for the CDC works. If required			
1(d)(ii)	Must have an approval for an on-site stormwater drainage system				
1(e)	If any driveway, crossover, or kerb is proposed, must have written consent from the relevant roads authority.	Note: This is a commonly overlooked requirement and can lead to delays in obtaining a CDC. Contact your local council for details and to request approval. Note: Other consents may be required under the <i>Roads Act 1993</i> if other road related works are proposed			
1(f)	If located in a 'mine subsidence district', must have prior approval from the Mine Subsidence Board.	Refer to your 10.7 planning certificate, section 5			
1(g)	Must not be a skylight or roof window in the local government area of Coonamble, Gilgandra, Warrumbungle Shire or that part of the local government area of Dubbo Regional that was formerly in the City of Dubbo	The objective of this clause is to minimise light pollution and protect observing conditions at the Siding Spring Observatory.			

Clause	Criteria	Comment	Complies?
1.18			Y N n/a
1(h)	If it involves the pruning or removal of a tree or other plants that requires development consent, to which Clauses 3.33 'development', 3A.7, 5A.3 of the Codes SEPP does not apply, a permit or development consent is needed prior to the issue of the CDC.	<p>Refer to your local council guidelines for tree protection controls.</p> <p>3.33, 3A.7 refer to different types of development (5A is commercial and industrial). If your development comes under Part 3 or Part 3A (in Step 3 of this Guide) refer back to this clause.</p> <p>Double check this clause prior to completing your application.</p>	
2	Sites within the 20-25 ANEF Contours must be constructed in accordance with <i>AS 2021:2025 Acoustics - Aircraft noise intrusion - Building siting and construction</i>	<p>ANEF contours refer to aircraft noise levels and are often found in areas under and around flight paths.</p> <p>Refer to your 10.7 planning certificate, section 3 for ANEF zone (if any).</p> <p>Sites in 25 ANEF or higher are referenced in clause 1.19(1)(h).</p> <p>Double check this clause prior to completing your application.</p>	
3	The complying development must comply with the relevant conditions specified in the policy	<p>The conditions are contained within the Schedules at the end of the Codes SEPP. The conditions differ depending on the development type.</p> <p>Double check this clause prior to completing your application.</p>	

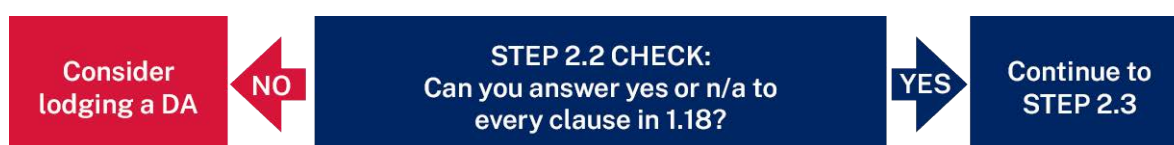

2.3. Land on which complying development may not be carried out

Clause 1.19

Note: Subclause (6) for 1.19 states that specific land based exclusions may apply to part of a lot. If your land partially contains areas or items that are excluded, complying development may still be possible on the parts of the land not identified as being excluded.

Clause	Criteria	Comment	Complies?		
			Y	N	n/a
1.19					
1	Specific land exemptions for: <ul style="list-style-type: none"> Housing Code Inland Code Low Rise Housing Diversity Code Rural Housing Code Developments under the above codes must not be carried out on:	The relevant development type and corresponding code was determined in Step 2 Note: excludes Part 4 Alterations and Additions			
1(a) must not be on:	land in a heritage conservation area, or draft heritage conservation area, unless detached outbuilding, detached development (other than a detached studio) or swimming pool	Refer to your 10.7 planning certificate, section 2, or Planning Portal Spatial Viewer. NSW Heritage maintains an inventory of heritage items .			
1(b) must not be on:	land that is reserved for a public purpose by an environmental planning instrument	Check the land reservation acquisition layer in the Spatial Viewer. Unlikely to apply as land reserved for a public purpose should not be a residential Zone.			
1(c) must not be	land identified on an acid sulfate soils map as being class 1 or class 2	Refer to your 10.7 planning certificate, section 7, or Planning Portal Spatial Viewer.			
1(c1) must not be	land that is significantly contaminated land	Refer to your 10.7 planning certificate, section 21, or contact council.			
1(d) must not be on:	land subject to a bio banking agreement, or a property vegetation plan	DPIE bio banking information Refer to Part 7A of the Threatened Species Conservation Act 1995 and the Native Vegetation Act 2003			
1(d1) must not be on:	land that is subject to a private land conservation agreement under the <i>Biodiversity Conservation Act 2016</i> , or that is set aside under section 60ZC of the <i>Local Land Services Act 2013</i>	Public register of private land conservation agreements Refer to the Biodiversity Conservation Act 2016 and the Local Land Services Act 2013			

Clause	Criteria	Comment	Complies?		
			Y	N	n/a
1.19					
1(e) must not be on:	land identified by an environmental planning instrument as being – i. within a buffer area, or ii. within a river front area, or iii. within an ecologically sensitive area, or iv. environmentally sensitive land, or	Refer to Planning Portal Spatial Viewer			
1(f) must not be on:	land that is identified by LEP, DCP or other planning document as being in: i. a coastline hazard, or ii. a coastal hazard, or iii. a coastal erosion hazard,	Refer to Planning Portal Spatial Viewer			
1(g) must not be on:	land in a foreshore area	Refer to Planning Portal Spatial Viewer			
1(h) must not be on:	land that is in the 25 ANEF contour or a higher ANEF contour, unless the development is only for – i. the erection of ancillary development, attached development or detached development, or ii. the alteration of, or an addition to, ancillary development, attached development or detached development,	ANEF contours refer to aircraft noise levels and are often found in areas under and around flight paths. Refer to your 10.7 planning certificate, section 3 for ANEF zone (if any). Note: attached and detached developments refers to garages, carports, sheds and the like. They are not houses.			
1(i) must not be on:	land that is declared to be a special area under the Water NSW Act 2014,	NSW Water Act 2014 - Special Areas			
1(j) must on:	unsewered land – i. to which SEPP (Sydney Drinking Water Catchment) 2011 applies, if that development will result in an increase to the number of bedrooms on the site or a site disturbance area of more than 250m ² , or ii. in any other drinking water catchment identified in any other environmental planning	If your project is on unsewered land, a DA will be required.			

Clause	Criteria	Comment	Complies?		
			Y	N	n/a
1.19					
2	<p>Specific land exemptions for:</p> <ul style="list-style-type: none"> Housing Code, Inland Code, Low Rise Housing Diversity Code, <p>Developments under the above codes <u>must not</u> be carried out as complying development if they appear on Schedule 5 of the Codes SEPP.</p>	Schedule 5 of the Codes SEPP contains a list of maps by local government area that outline specific areas in which complying development is not possible. Check your land is not on these maps.			
3	<p>3a The exclusions in subclause 2 cease to have effect:</p> <p>a. (no longer applies)</p> <p>b. on 30/11/23 all maps for Mosman in Schedule 5</p> <p>c. on 31/12/22 all maps for the City of Sydney in Schedule 5</p>	If your land is identified on these maps in Schedule 5, complying development is no longer prohibited after the specified date.			
3A	<p>Specific land exemptions for:</p> <ul style="list-style-type: none"> Low Rise Housing Diversity Code <p>Complying development must not be carried out on land on which there is a heritage item of a draft heritage item</p>	<p>Refer to your 10.7 planning certificate, section 2, or Planning Portal Spatial Viewer.</p> <p>NSW Heritage maintains an inventory of heritage items.</p>			
4	<p>Specific land exemptions for:</p> <ul style="list-style-type: none"> Housing Alterations Code <p>To be complying development, must not be carried out on unsewered land:</p> <p>a. to which SEPP (Sydney Drinking Water Catchment) 2011 applies, if that development will result in an increase to the number of bedrooms on the site or in a site disturbance area of more than 250m², or</p> <p>b. in any other drinking water catchment identified in any other environmental planning instrument.</p>				

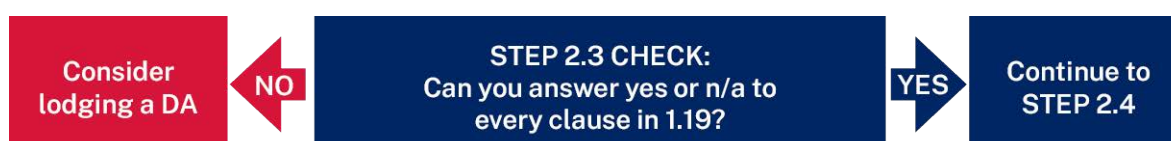

2.4 Bushfire prone land

Clause 1.19A

A 10.7 planning certificate and the Planning Portal Spatial Viewer will identify if your land is located on bush fire prone Land.

Depending on the criteria in the table below, complying development may still be possible on your land even if it is identified as bush fire prone land.

Regardless of the clause 1.19A, if your land is on bush fire prone land, any works will be required to comply with the provisions in the BCA for bush fire prone land.

Terraces under Part 3B of the Codes SEPP are prohibited from all bushfire prone land, regardless of the BAL

Definition of 'BAL'

BAL is the bush fire attack level category that has been assigned to land describing the amount of risk that the property is at in the event of a bush fire attack.

BAL-FZ and BAL-40 are the two highest risk categories. More information on how to determine the BAL of your site may be found on the [NSW Rural Service website](#) or by contacting a Bush Fire Consultant through the [Fire Protection Association Australia](#)

Clause	Criteria	Comment	Complies?		
			Y	N	n/a
1.19A					
1	<p>For all complying development (except Part 4 Housing Alterations Code)</p> <p>a. the development must not be carried out on land in Bush Fire Attack Level 40 (BAL-40) or the Flame Zone (BAL-FZ), and</p> <p>b. for development under the Rural Housing Code any access way to the development must be on land that is</p> <ul style="list-style-type: none"> • not in BAL-40 or BAL-FZ, or • grasslands 	<p>To determine if your land is in bushfire prone land:</p> <ul style="list-style-type: none"> • Refer to your 10.7 planning certificate, section 7, or • Planning Portal Spatial Viewer. <p>To determine the BAL: contact the NSW Rural Fire Service, or a Bush Fire Consultant.</p>			
2	<p>Does not apply to:</p> <ul style="list-style-type: none"> • non-habitable detached development that is more than 6m from any dwelling house, • landscaped areas, • non-combustible fences, • swimming pools. 				

Clause	Criteria	Comment	Complies?		
			Y	N	n/a
1.19A					
3	Land is not BAL-40 or BAL-FZ if				
	a. council or a suitably qualified consultant have determined the land to not be BAL-40 or BAL-FZ	If you have engaged with council, or a suitably qualified consultant to define your risk as not BAL-FZ or BAL-40, complying development may be possible on your land.			
	b. on grasslands, the development conforms to the specifications and requirements of Table 7.9a of <i>Planning for Bush Fire Protection</i>	Development may be possible on grasslands with a BAL-40 or BAL-FZ provided the criteria are met.			
4	Complying development may be carried out on part of a lot that is not bush fire prone land	If your land is partially within BAL-40 or BAL-FZ, complying development may be possible on the area outside of these areas.			
5	Grasslands has the same meaning as defined in <i>Planning for Fire Protection</i>	For reference			

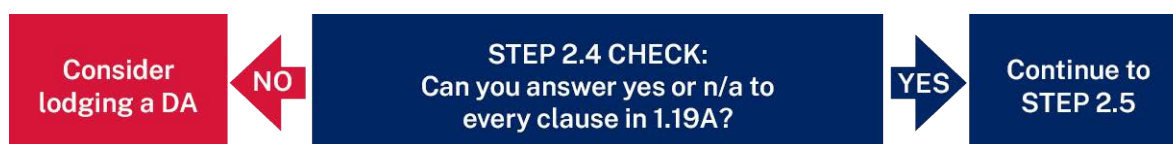

2.5 Flood control lots

Flood risk is a critical consideration for all development.

Flood control lots are generally mapped and described in your local council DCP (not the LEP). Flood risks will also be identified in section 7A of a 10.7 planning certificate.

Complying development may be possible on your land if flood risks are identified provided certain criteria are met.

The specific development standards that must be met for sites on flood control lots are defined in the Parts 3 and 4 of the Codes SEPP for each of the relevant development type (eg, Inland Housing Code, Rural Housing Code etc)

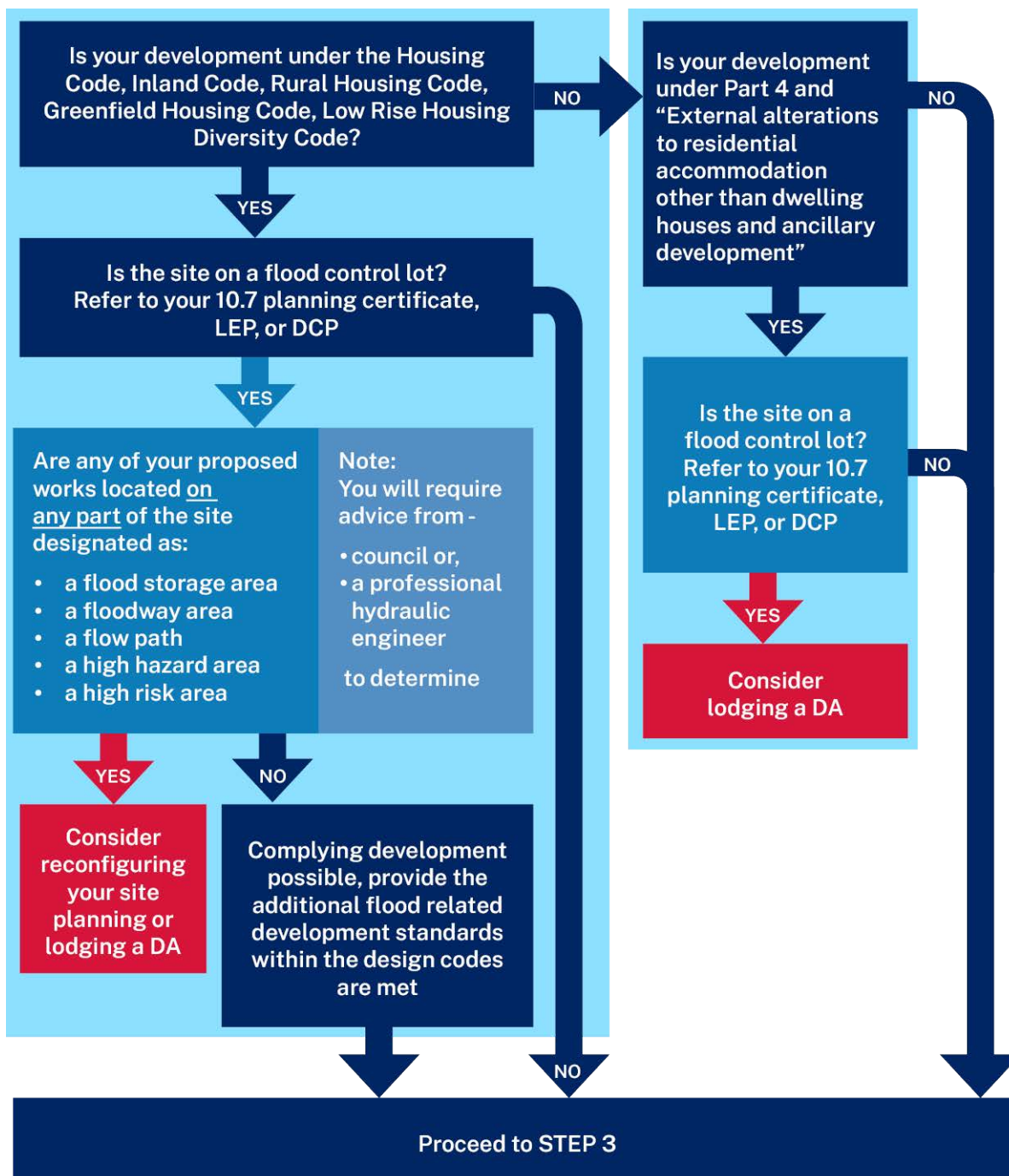

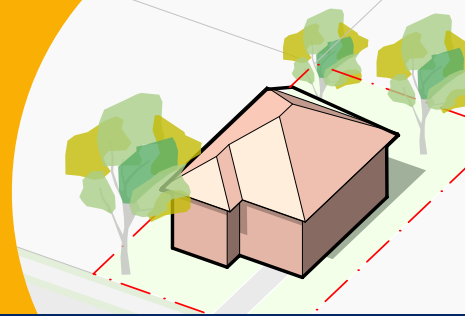
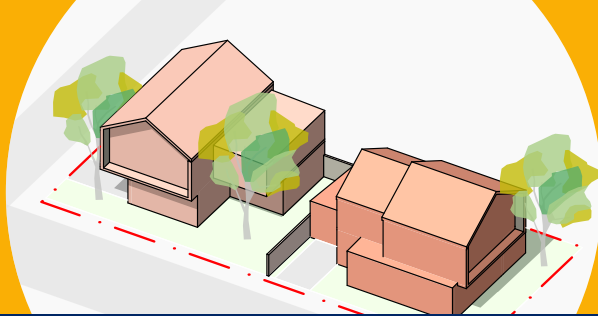
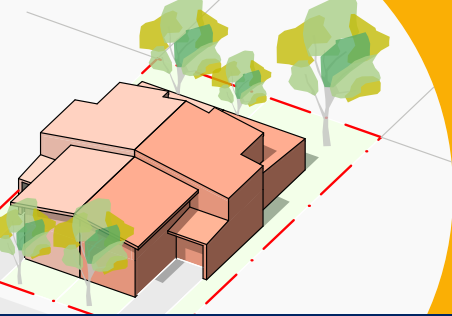

Step 3

Determine what type of development
Development standards

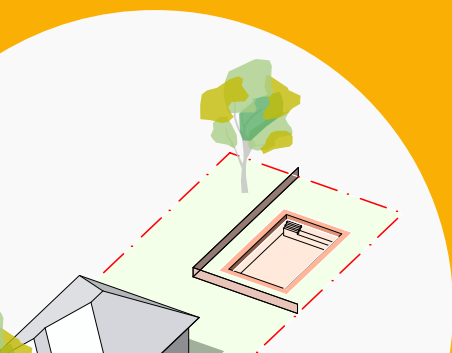
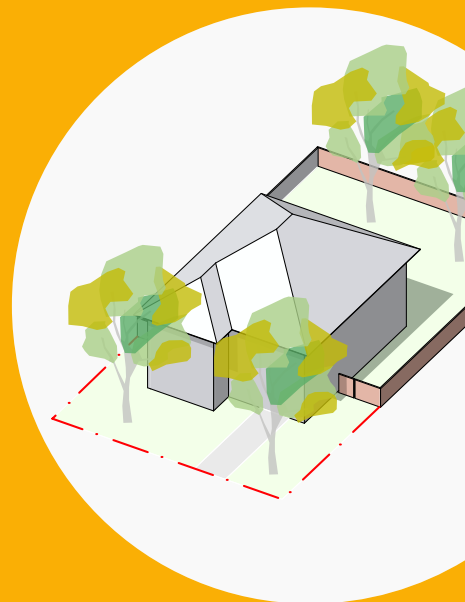
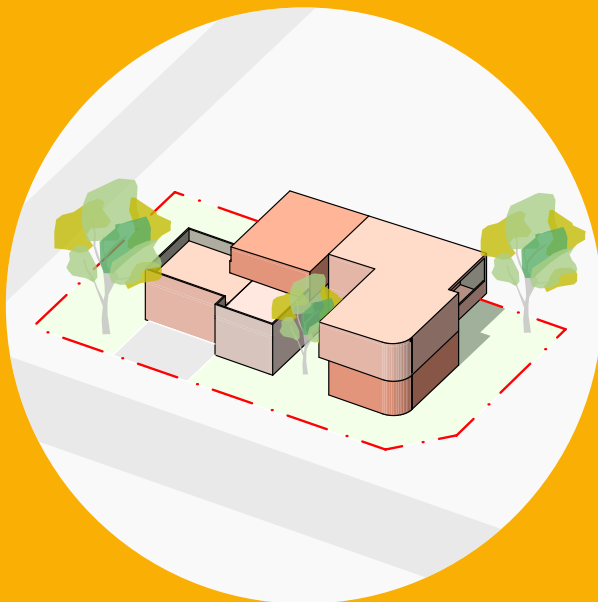
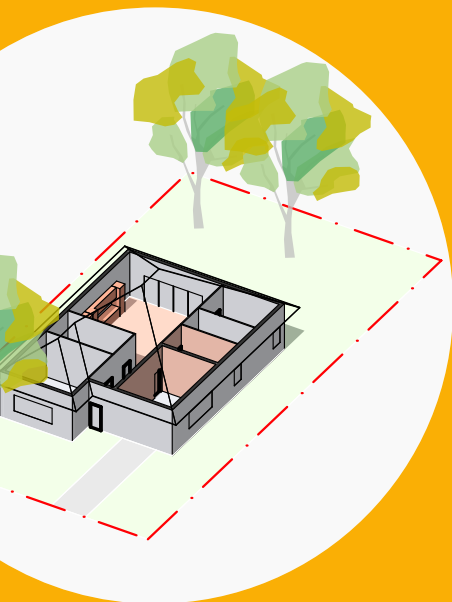
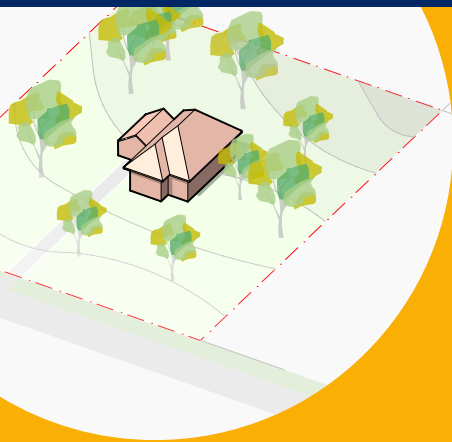

Which code applies?

Part 3 and Part 4 of the Codes SEPP are broken down into a series of individual Codes that have specific controls and standards for specific land areas and types of development.

Tip: A Section 10.7 planning certificate, section 3 will state what category of complying development is possible on your land (if any).

The flowchart on the following page provides a step by step process to determine which code you should follow.

The key development standards for each Code have been summarised in a series of colour coded booklets.

In Step 4 of this Guide, explanatory guidance is provided for the key controls and definitions.

STEP 3 CHECK:

Have you determined the correct Code relevant to your project?

Have you reviewed the development standards relevant to your project?

YES

Proceed to STEP 4

Case study

A family has recently purchased a block of vacant land in a bushland suburb in metropolitan Sydney where they plan to build a two storey house. They are unclear about which Code applies to their proposed development.

The family should approach the local council to find out whether complying development can be carried out on their land or obtain a section 10.7(2) planning certificate. If these two options are not possible, they can follow the Steps in this Guide.

They find out the zoning of their land (RU1 Rural) from the Planning Portal Spatial Viewer.

While on the Planning Portal, they confirm that their land has not been earmarked as a Greenfield Housing Code area. They check that their land is not in on the Inland Housing Code local council areas.





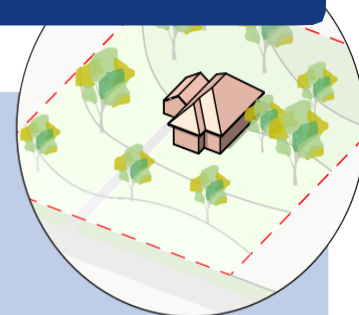

With this information, they confirm that their project would fall under the Rural Housing Code and take note of this for future reference.

They then proceed to check that the other particulars of their land comply with the requirements of the Codes SEPP by following Step 2 of the Guide.



Determining the applicable code

Refer to section 3 of your 10.7 planning certificate, or follow the steps below:

Single Dwellings	Confirm if permitted in your zoning	Applicable Code for Step 4
<p>Is your site located in a Greenfield Housing Code area? (See explanation on following page)</p>	<p>R1, R2, R3, R4 or RU5</p>	 <p>Greenfield Housing Code</p>
<p>No</p>		
<p>Is your site located in an “Inland NSW” local council area? (See explanation on following page)</p>	<p>RU1, RU2, RU3, RU4, RU5, RU6, R1, R2, R3, R4 or R5</p>	 <p>Inland Code</p>
<p>No</p>		
<p>Is the proposal for a new or renovated detached single dwelling, garage or carport (not in a heritage area)? Or a detached outbuilding or swimming pool (including within heritage areas)?</p>	<p>R1, R2, R3, R4 or RU5</p>	 <p>General Housing Code</p>
<p>No</p>		
<p>Is the site located on rural zoned land (RU1, RU2, RU3, RU4, RU6 or R5) ?</p>	<p>RU1, RU2, RU3, RU4, RU6 or R5</p>	 <p>Rural Housing Code</p>
<p>No</p>		
<p>Is the work minor in nature? For example: - Attic conversion - Internal alteration Or located in a heritage conservation area?</p>	<p>Varies depending on type</p>	 <p>Housing Alterations Code</p>
<p>No</p>		
<h3>Multiple dwellings</h3>		
<p>Will the work result in multiple dwellings? (I.e. terraces, attached/detached dual occupancy or manor housing)</p>	<p>R1, R2, R3 or RU5</p>	 <p>Low Rise Housing Diversity Code</p>

Greenfield housing

Greenfield areas are new land release areas across NSW that have been designated to meet the needs of the State's growing population and to improve housing affordability.

You can determine if your land is within a Greenfield Housing Code area in the following ways:

- Refer to your 10.7 planning certificate
- View your land in the Planning Portal [Spatial Viewer](#) with the Greenfield Housing Code Area layer selected.
- Refer to the [Greenfield Housing Code Area maps](#) on the DPE website.

Inland Housing Code

The Inland Housing Code applies to the following local council areas (excluding any areas nominated as Greenfield sites):

Albury City
 Armidale Regional
 Balranald
 Bathurst Regional
 Berrigan
 Bland
 Blayney
 Bogan
 Bourke
 Brewarrina
 Broken Hill
 Cabonne
 Carrathool
 Central Darling
 Cobar
 Coolamon
 Coonamble
 Cootamundra-Gundagai Regional
 Cowra
 Dubbo Regional
 Dungog
 Edward River
 Federation,
 Forbes Gilgandra
 Glen Innes Severn- Shire Goulburn
 Mulwaree Greater Hume Shire
 Griffith
 Gunnedah Gwydir Hay Hilltops
 Inverell Junee Lachlan Leeton
 Lithgow
 Liverpool Plain Lockhart
 Mid-Western Regional
 Moree Plains
 Murray River
 Murrumbidgee
 Muswellbrook
 Narrabri

Narrandera
 Narromine
 Oberon
 Orange
 Parkes
 Queanbeyan
 Palerang Regional
 Singleton
 Snowy Monaro-Regional
 Snowy Valleys
 Tamworth Regional
 Temora
 Tenterfield
 Upper Hunter Shire
 Upper Lachlan-Shire
 Uralla Wagga
 Wagga
 Walcha
 Walgett
 Warren
 Warrumbungle Shire
 Weddin
 Wentworth
 Yass Valley

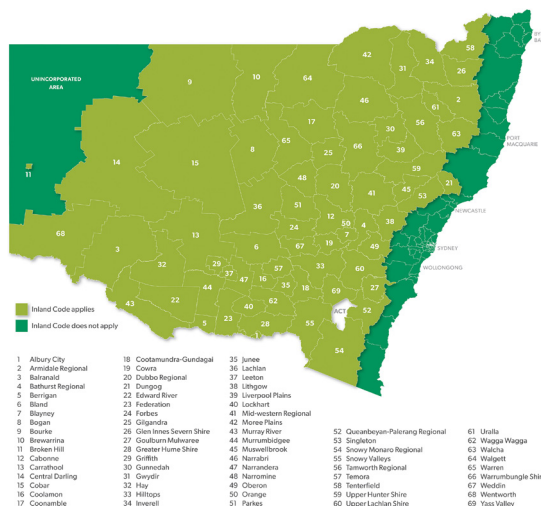

PLANNING PORTAL [MAP](#) OF WHERE THE INLAND CODE APPLIES

The Code books

The Code books provide a summary of the key development standards for each housing Code and provide:

- a summary of the code
- summary tables of the key development standards
- summaries of the design criteria that must be complied with
- links to the relevant clause in the Codes SEPP for more detail

NOTE: The Codes SEPP and your local council LEP lists variations to the complying development code which apply in some local council areas.

Schedule 3 of the Codes SEPP:

Contains a list of variations for some local council areas. Search for your area, and determine if any of the variations apply to your site.

Part 3 and Schedule 3 of the LEP:

Your council may have additional opportunities or restrictions for exempt and complying development within the LEP. Check these clauses for further

These variations must be applied to your project.

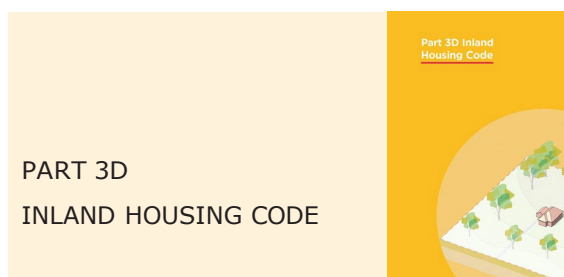
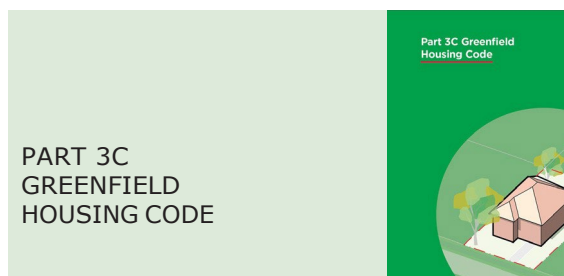
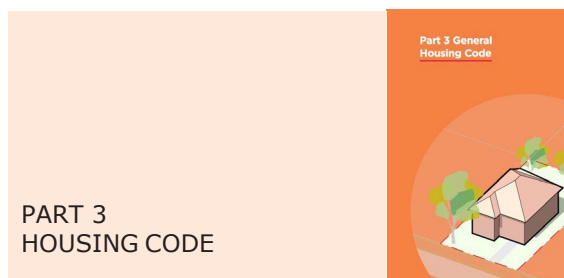

Step 4

The Housing Codes - key development standards

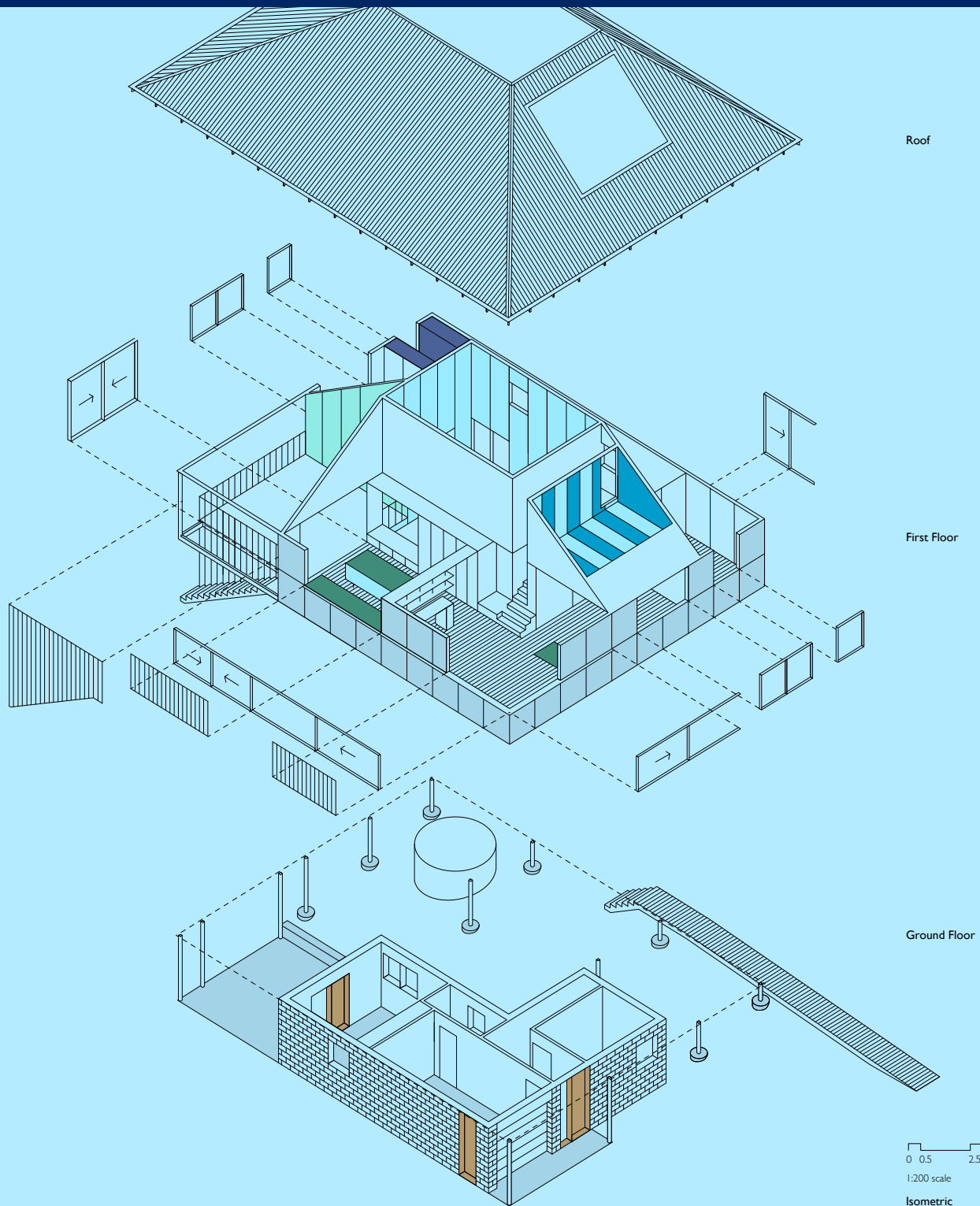

Part 3 Housing Code

Summary of key development standards

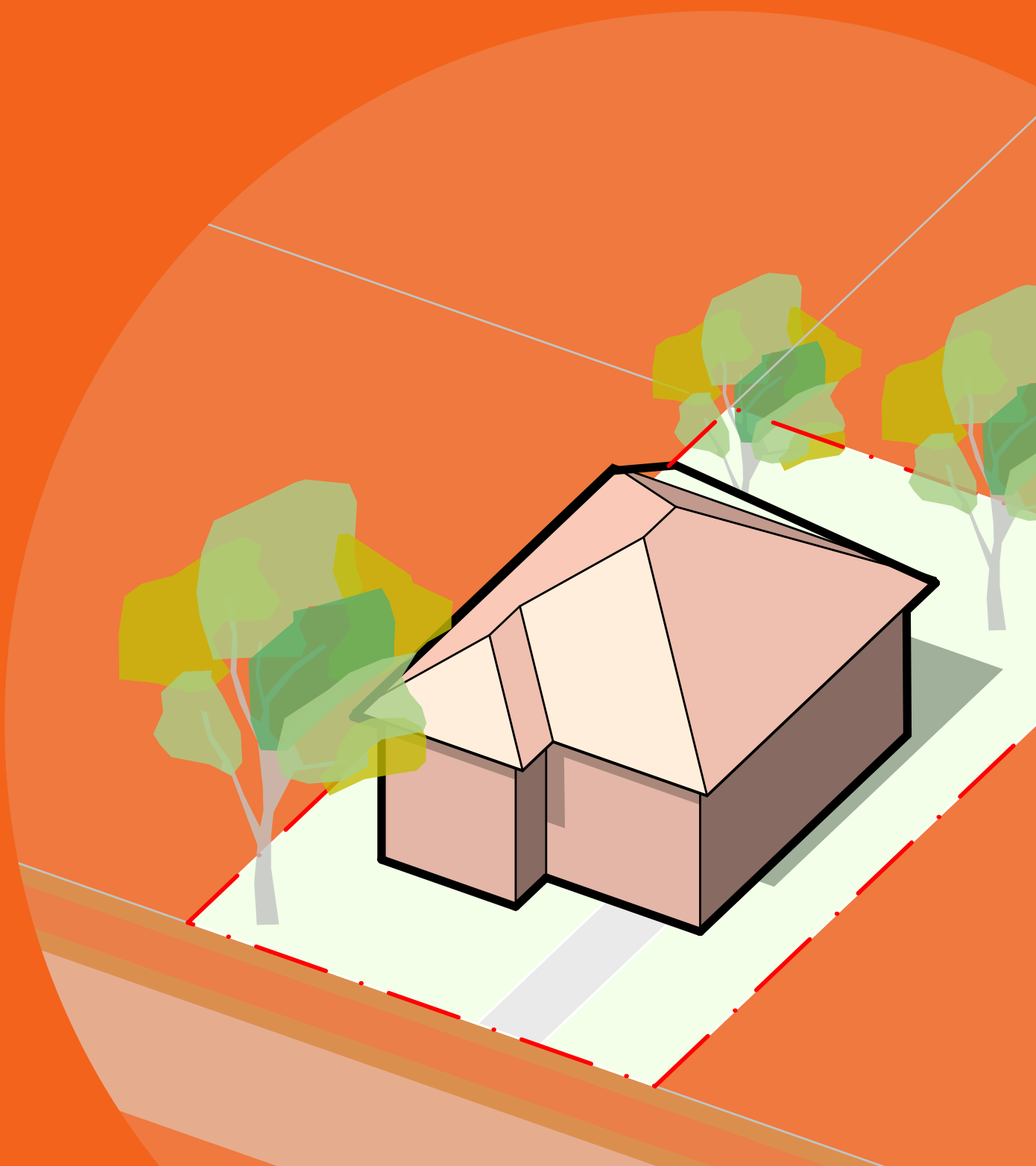

Before you start

What is complying development under this code?

For works to be complying development under Part 3 Housing Code of the Codes SEPP the proposed works must be for:

- The erection, alteration or addition to any 1 or 2 storey dwelling house or any attached development
- The erection, alteration or addition of any detached development

The site must meet the following requirements:

- located in zone R1, R2, R3, R4 or RU5
- be at least 200m² in size
- be at least 6m wide (as measured at the building line)
- only result in 1 dwelling house on the lot at the completion of the development
- have lawful access to a public road at completion of the development
- if the development is on a battle-axe lot — the lot must be at least 12m by 12m (not including the access laneway) and must have an access laneway that is at least 3m wide
- if the development is on a corner lot — the width of the primary road boundary of the lot must be at least 6m

Secondary dwellings (granny flats)

A secondary dwelling with a separate development or complying certificate consent does not count towards the limit of 1 dwelling house per site.

This code does not apply to secondary dwellings. Refer to the [Housing SEPP](#) for complying development standards for secondary dwellings (e.g. granny flats).

What is not complying development under this code?

For works to be complying development under Part 3 Housing Code of the Codes SEPP the works must not be for:

- the erection, alteration or addition to, a roof terrace on the top most roof of a building
- development that is complying development under the Housing Alterations Code
- development that is attached to a secondary dwelling or group home,
- the erection of a building over a registered easement
- the erection of a common wall,
- the alteration of, or an addition to, a garage or carport that is located forward of the building line
- the construction of a basement that will have an area that exceeds the limits shown in the table below:

Lot width	Maximum basement area
6-10m	25m ²
>10m	45m ²

Note: Some councils have additional land exemptions and variations to complying development. Refer to the Schedule 3 of the Codes SEPP and the LEP to confirm if any of these apply to your land.

Bushfire prone land

[clause 3.4](#)

For land that is bushfire prone, but permissible under clause 1.19A of the Codes SEPP (and as detailed in Step 3.4 of this Guide), additional development controls are required.

Refer to [clause 3.4 for the detailed requirements](#).

The development must conform to the specifications and requirements of *Planning for Bush Fire Protection* that are relevant to the development

Floodcontrol lots

[clause 3.5](#)

For land that is flood prone, but not high hazard or high risk (and as detailed in Step 3 of this Guide), complying development may be possible provided additional criteria are met.

Refer to [clause 3.5 for the detailed requirements](#).

Further input from council or a hydraulic engineer will be required on flood control lots.

A section 10.7 certificate from council will state whether or not a lot is a flood control lot.

Summary of key development standards

The development standards summary tables provide details on the key controls only in the relevant Codes SEPP. Refer to the specific clauses in the Codes SEPP for further detail and Part 4 of this Guide for explanatory guidance.

Development standards (based on lot area)

Lot Size	200 -250m ²	250 -300m ²	300 -350m ²	350 -450m ²	450 -560m ²	560 -600m ²	600 -740m ²	740 -900m ²	900 -920m ²	920 -1,000m ²	1,000 -1,500m ²	+1,500m ²
All developments												
Combined lot floor area 3.9	78%	75%	235m ²	25% of lot area + 150m ²	290m ²	25% of lot area + 150m ²	335m ²	25% lot area + 150m ²	380m ²	25% lot area + 150m ²	400m ²	
Parallel road setback 3.10 (2) 3.11 (6)	3m. <3m for certain attached developments for a maximum of 50% width of rear boundary if parallel road is not classified											
Minimum landscape 3.13 (1) (2)	10%	15%	20%	30%	40%	45%						
Dwelling house and attached developments												
Maximum storeys 3.1	2											
Height 3.8	8.5m											
Primary road setback 3.10 (1) (3)	3m or average	4.5m or average					6.5m or average	10m or average				
Rear setback 3.10 (10)	<4.5m high = 3m >4.5m high = 10m or average neighbours	<4.5m high = 3m >4.5m high = 8m					<4.5m high = 5m >4.5m high = 12m		<4.5m high = 10m >4.5m high = 15m			
Secondary road setback 3.10 (11)	2m					3m			5m			
Classified road setback 3.10 (13)	9m or as noted in planning instrument											
Public reserve setback 3.10 (14)	3m											

Lot Size	200 -250m ²	250 -300m ²	300 -350m ²	350 -450m ²	450 -560m ²	560 -600m ²	600 -740m ²	740 -900m ²	900 -920m ²	920- 1,000m ²	1,000 - 1,500m ²	+1,500m ²
Front setback (battle axe lot) 3.10 (15)	3m											
Rear lane setback 3.11 (5)	<0.9m permitted for a maximum of 50% width of the rear boundary for lots adjoining a laneway											
Additional standards - detached developments (excluding studios)												
Maximum building height 3.18	4.5m											
Floor area 3.20	36m ²		45m ²		60m ²			100m ²				
Primary and secondary road setback 3.21	Behind building line (except detached garages and carports)											
Rear setback 3.21 (8)	0.9m						1.5m			2.5m		
Secondary road setback (garages or carports) 3.23 (6)	2m				3m				5m			
Additional standards - detached developments (studios)												
Building height 3.25 (2)	4.8m or, 6m - If the studio is within 0.9m of a lane.											
Floor area 3.25 (3)	20m ²	36m ²										

Development standards (based on lot width)

Lot width	6-10m	10-12m	12-12.5m	12.5-18m	18-24m	+24m
All developments						
Basement area 3.2	25m ²		45m ²			
Side setback 3.10 (4)	up to 5.5m = 0.9m above 5.5m = (building height - 5.5m) ÷ 4 + 0.9m	up to 4.5m = 0.9m above 4.5m = (building height - 4.5m) ÷ 4 + 1.5m		up to 4.5m = 1.5m above 4.5m = (building height - 4.5m) ÷ 4 + 1.5m	2.5m	
Maximum built to boundary walls 3.10 (5) (6)	may build to both sides (subject to conditions)	may build to one side (subject to conditions)		Not permitted		
Maximum built to boundary wall height 3.10 (7)	3.3m or not higher than neighbouring built to boundary wall			Not permitted		
Maximum built to boundary wall length 3.10 (8)	20m, or 50% of lot depth, or length of neighbouring built to boundary wall	10m or length of neighbouring built to boundary wall		Not permitted		
Landscape area: min. width 3.13 (2)	1.5m					
Landscape area: front setback 3.13 (3)	25% of landscape area to front of building line must be landscaped			50% of landscape area to front of building line must be landscaped		
Landscape area: behind building line setback 3.13 (4)	50% of landscaped area must be located behind the building line to the primary road					
Private open space 3.13 (4)	16m ²		24m ²			
Maximum garage door openings (excl. Lanes) 3.16 (6)	3.2m		6m			

Lot width	6-10m	10-12m	12-12.5m	12.5-18m	18-24m	+24m					
Detached developments (excluding studios)											
Side setbacks 3.21 (2)	0.9m			1.5m	2.5m						
Parallel roads or rear lanes 3.26 (4)	<3m for certain attached developments for a maximum of 50% width of rear boundary if parallel road is not classified										
Additional standards - detached developments (studios)											
Side and rear setbacks 3.25 (4)	0.9m			1.5m							
	Built to boundary may be permissible subject to conditions										
Additional standards											
Setback exceptions 3.11	Encroachments within the required setbacks are permitted in certain instances for minor building elements listed in clause 3.11										
Outdoor entertainment areas 3.12	<p>These standards apply to attached balconies, decks, patios, pergolas, terraces and verandahs.</p> <p>A balcony, deck, patio, terrace or verandah attached to the side or rear elevation is only permitted if:</p> <ul style="list-style-type: none"> the lot area is greater than 300m² the lot width is greater than 10m <p>The maximum combined floor area for all balconies, decks, patios, pergolas, terraces and verandahs attached to a dwelling house with a floor level more than 2m above the existing ground level and within 6m of the side or rear boundary must not be more than 12m².</p>										
	<p>Maximum height</p> <p>Attached</p> <p>Setback from the side or Maximum floor level above ground rear boundary (existing)</p> <table border="0"> <tr> <td><3m</td> <td>2m</td> </tr> <tr> <td>3m-6m</td> <td>3m</td> </tr> <tr> <td>>6m</td> <td>4m</td> </tr> </table> <p>Detached Maximum floor level above ground (existing)</p> <p>Any detached deck, patio, 0.6m pergola, terrace or verandah</p>						<3m	2m	3m-6m	3m	>6m
<3m	2m										
3m-6m	3m										
>6m	4m										
Building design 3.14	Controls for the location and number of windows and doors, design features, and allowable encroachments into articulation zones.										

Windows, doors, and openings 3.14	<p>No wall within 900mm of a side boundary may have a window, door, or any other opening.</p> <p>Standard and parallel lots</p> <p>A dwelling house must have at least -</p> <ul style="list-style-type: none"> • 1 window to a living area or a bedroom ('habitable room'), and • 1 door - <p>facing the primary road or parallel road.</p> <p>A new dwelling house on a corner lot must have a window to a living area or a bedroom ('habitable room') of at least 1m² that faces and is visible from the secondary road.</p>	
Privacy screens 3.15	Privacy screens must be provided in certain situations. Refer to 3.15 and Part 4 of the Guide	
Car parking and access 3.16	Site detail	Control
	Lot width >8m	Min 1x car space
	Lot width <8m	A garage may only be built if accessed off secondary road, parallel road, or lane
	Battle axe lot	vehicles must leave in a forward direction
	Alterations and additions At least 1 car space must be retained to	
Heritage conservation areas 3.22	Detached developments on lots adjoining lanes, secondary roads, or parallel roads are not permissible in heritage conservation areas (HCA) or draft heritage conservation areas.	
	<p>Detached developments adjoining other lots must be:</p> <ul style="list-style-type: none"> - Located behind the building line of the dwelling house - No closer to side boundaries than the dwelling house - Gross floor area of <20m² 	
Detached studios 3.25	Additional development standards apply for detached studios that vary to those for other detached developments.	
Swimming pools 3.28	<p>Controls for the design and placement of swimming pools. Refer to 3.28 and Part 4 of the Guide.</p> <p>Pools must comply with the BCA and Australian Standards for pool and pool fencing.</p>	
Fences 3.29	Controls for the design and placement of fences. Refer to 3.29 and Part 4 of the Guide.	
Earthworks 3.30	Controls for excavation, fill and retaining walls. Additional development standards outline when professional input is required.	
Drainage 3.31	<p>Stormwater must be directed by a gravity fed system to:</p> <ul style="list-style-type: none"> - a public drainage system - an inter-allotment drainage system 	
Protecting adjoining walls 3.32	Any wall built within 900mm of a boundary requires a professional engineer's report.	
Protected trees 3.33	Controls for pruning and removing trees, and protected trees. Refer clause 3.33 and Part 4 of the Guide for guidance.	

Part 3A

Rural Housing Code

Summary of key development standards



Before you start

What is complying development under this code?

For works to be complying development under Part 3A Rural Code of the Codes SEPP the proposed works must be for:

- the erection of any 1 or 2 storey dwelling house* on a lot in:
 - Zone R5, or
 - in zone RU1, RU2, RU4 and RU6 that has an area of least 4,000m²
- This does not apply if the size of the lot is less than the minimum lot size under the environmental planning instrument (eg LEP) applying to the lot.
- the alteration or addition to any 1 or 2 storey dwelling house on a lot in:
 - Zone R5, or
 - Zone RU1, RU2, RU3, RU4 and RU6 that has an area of least 4,000m²
- the erection, alteration or addition of any outbuilding on a lot in:
 - Zone R5, or
 - Zone RU1, RU2, RU3, RU4 and RU6 that has an area of least 4,000m²

Lot requirements

[clause 3A.9](#)

Lot requirements:

- only result in 1 dwelling house on the lot at the completion of the development
- if the development is in zone R5 and on a battle-axe lot – the lot must be at least 12m by 12m (not including the access laneway) and must have an access laneway that is at least 3m wide
- if the development is in zone R5 and is not a battle-axe lot, the lot must be at least 18m wide
- have lawful access to a public road at completion of the development

Refer to [clause 3A.9](#) for the detailed requirements.

What is not complying development under this code?

Exclusions to complying development under Part 3A of the Codes SEPP include:

- the erection or alteration of, or an addition to a roof terrace on the top most roof of a building,
- erection of a dwelling house in zone RU3
- development that is complying development under the Housing Alterations Code,
- development on any lot on which there is a secondary dwelling or group home,

Bushfire prone land

[clause 3A.37](#)

For land that is bushfire prone, but permissible under clause 1.19A of the Codes SEPP (and as detailed in Step 3.4 of this Guide), additional development controls are required.

Refer to [clause 3A.37](#) for the detailed requirements.

Flood control lots

[clause 3A.38](#)

For land that is flood prone, but not high hazard or high risk (and as detailed in Step 3 of this Guide), complying development may be possible provided additional criteria are met.

Refer to [clause 3A.38](#) for the detailed requirements.

Summary of key development standards

The development standards summary tables provide details on the key controls only in the relevant Codes SEPP. Refer to the specific clauses in the Codes SEPP for further detail and Part 4 of this Guide for explanatory guidance.

Development standards (based on lot size)

Development Standard	R5	R5	RU1, RU2, RU3, RU4, RU6
	<4,000m ²	4,000m ² +	
Dwelling house			
Permitted development type	New dwelling house,	New dwelling house	New dwelling house* *Excludes RU3
3A.2			(min site 4,000m ²)
3A.3			
3A.5	Alteration and additions	Alteration and additions	Alteration and additions (min site 4,000m ²)
	Ancillary development	Ancillary development	Ancillary development (min site 4,000m ²)
Maximum site coverage 3A.10	30%	No maximum	No maximum
Maximum floor area (dwelling house) 3A.11	430m ²	No maximum	No maximum
Maximum building height (dwelling house) 3A.14 (1) (2) (3) (5)	8.5m*	10m*	10m*
	*Siting controls on certain sloping land, which may influence the location and height of development.		
Primary road setback 3A.15 (1) (2)	Average or 10m	R5 = 15m	RU4 = 30m RU1, RU2, RU3 or RU6 = 50m
Secondary road setback 3A.15 (3)	5m	10m	10m
Parallel road setback 3A.15 (4)	10m	N/A	N/A
Classified road 3A.15 (5)	As specified in EPI or the relevant primary or secondary road setback (whichever is greater)		
Side setback 3A.16	2.5m	10m	10m
Rear setback 3A.17	15m	15m	15m

Minimum landscape area 3A.24	45% of lot	No minimum	No minimum
Principal private open space 3A.25	24m ² (min 3m wide and not steeper than 1:50)	N/A	N/A
Minimum car parking 3A.26	new dwelling house = 1 spot provided	N/A	N/A
	alterations and additions = 1 spot retained		
Garage /carport primary road setback 3A.27	5.5m minimum and at least 1m behind the building line	N/A	N/A
Garage openings	Max 6m and for lot frontage >15m: max 50% building width or lot frontage <15m: max 60% building width (as measured at building line)		
Open hard stand parking minimum dimensions 3A.27 (4)	2.6m x 5.4m		
Outbuildings			
Maximum floor area (outbuilding) 3A.12	Agriculture use = 500m ²	No maximum	No maximum
	Other = 100m ²		
Maximum building height (outbuilding) 3A.14 (4)	4.8m	4.8m	4.8m
Maximum building height (outbuilding - farm building) 3A.14 (4) (c)	7m	7m	7m
Side and rear setbacks	Agriculture use = 10m Other = 5m		

Additional standards	
Outdoor entertainment areas 3A.13	Development standards apply to outdoor living areas to minimise potential impacts on neighbouring properties. Standards applies to attached balconies, decks, patios, pergolas, terraces and verandahs. Refer to clause 3A.13 for detailed requirements.
Setback exceptions 3A.19 (C) (c1)	Setbacks do not apply to certain building elements listed in clause 3A.19 such as downpipes, driveways, and paving.
Building design 3A.21-22	Controls for the location and number of windows and doors, design features, and allowable encroachments into articulation zones.
Privacy screens 3A.23	Privacy screens must be provided in certain situations. Refer to 3A.23 and Part 4 of the Guide
Protected trees 3A.24A	Controls for pruning and removing trees, and protected trees. Refer clause 3A.24 and Part 4 of the Guide for guidance.
Private open space 3A.25	Principal private open space is a recreation area such as a deck, patio or paved area which is directly accessible from a living area. On smaller R5 lots, development standards define minimum requirements for private open space.
Earthworks 3A.29	Controls for excavation, fill and retaining walls. Additional development standards outline when professional input is required.
Drainage 3A.32	Stormwater must be directed by a gravity fed system to: <ul style="list-style-type: none"> - a public drainage system - an inter-allotment drainage system - an on-site disposal system
Swimming pools 3A.33	Controls for the design and placement of swimming pools. Refer to 3A.33 and Part 4 of the Guide. Pools must comply with the BCA and Australian Standards for pool and pool fencing.
Detached studios 3A.33A	Additional development standards apply for detached studios that vary to those for other detached developments.
Outbuildings 3A.36	Additional development standards apply for outbuildings that vary from those for dwelling houses to reflect the smaller scale of detached developments

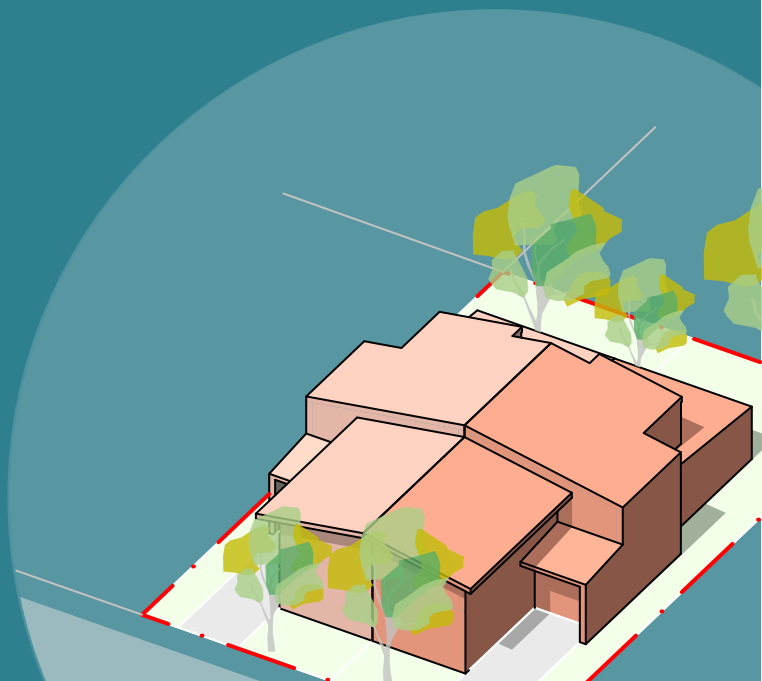
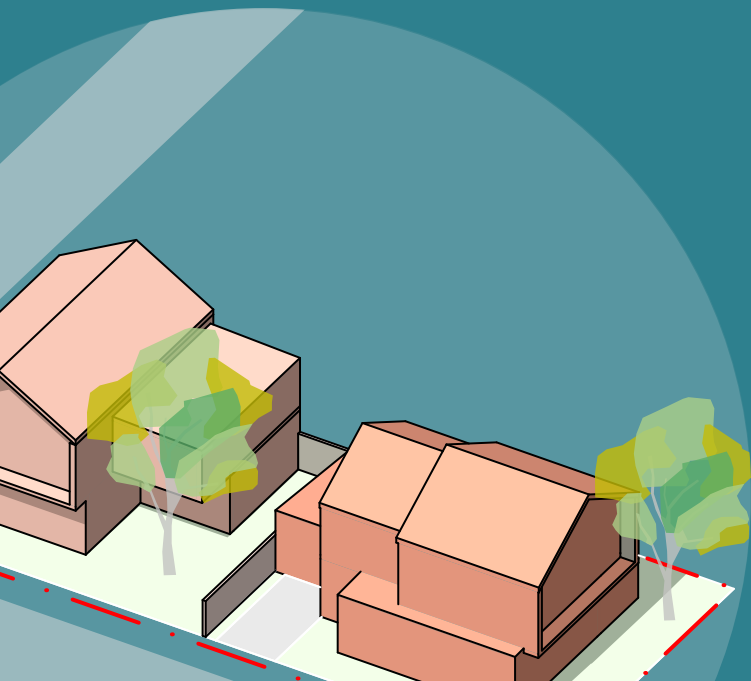

Part 3B

Low Rise Housing

Diversity Code

Summary of key development standards

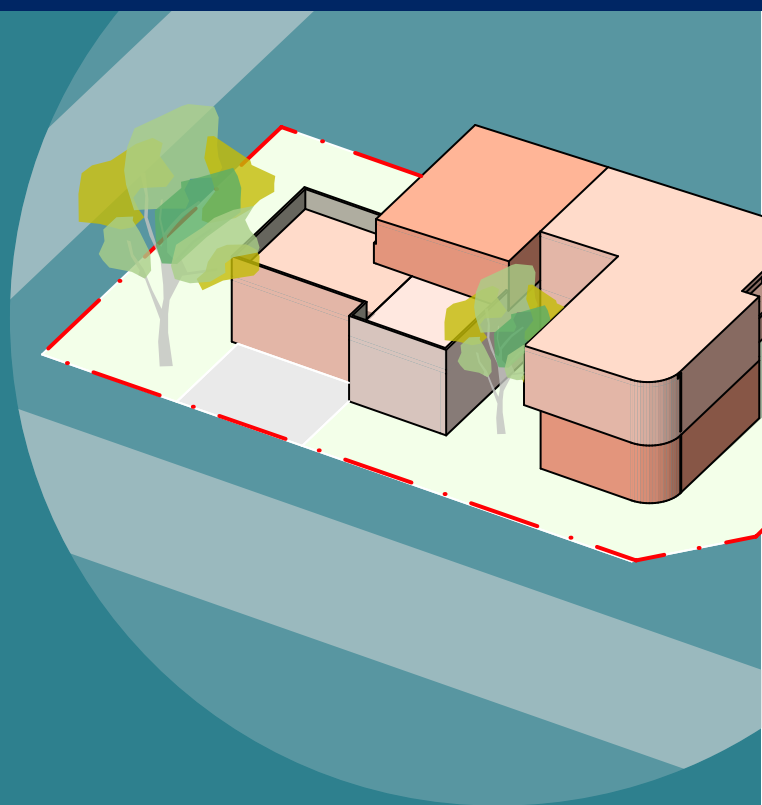
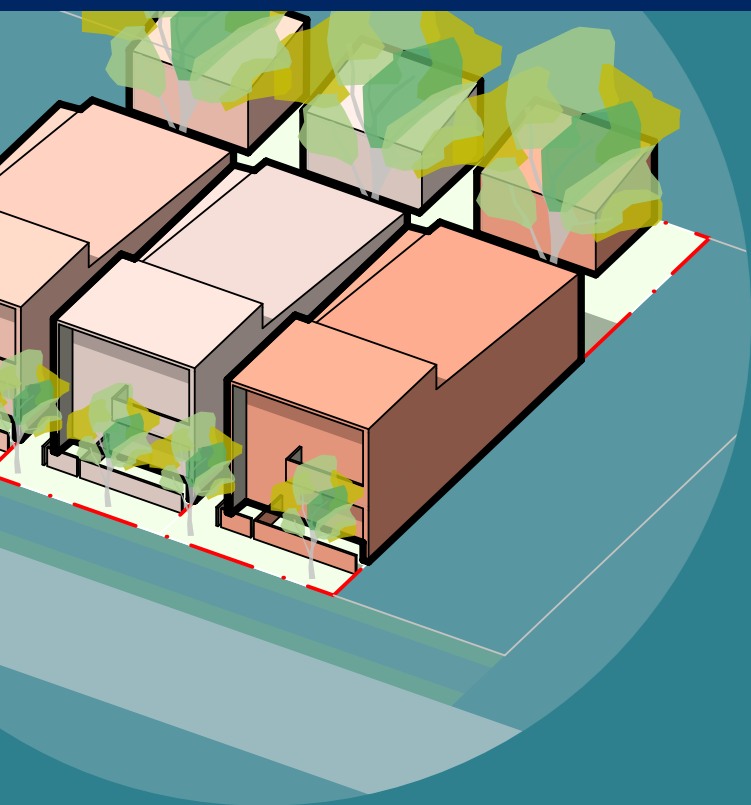

Contents

Before you start	4:3B-2
About the Low Rise Housing	
Diversity Code	4:3B-2
LRHD Design Guide and Design Verification	4:3B-2
What is complying development under this code?	4:3B-3
What is not complying development under this code?	4:3B-3
Subdivision	4:3B-4
Dual occupancies (side by side)	4:3B-5
Description	4:3B-5
Development standards	4:3B-6
Manor houses and dual occupancies (one above the other)	4:3B-7
Manor Houses	4:3B-7
Dual occupancy (one above the other)	4:3B-7
Development standards	4:3B-8
Multi dwelling houses (terraces)	4:3B-10
Description	4:3B-10
Development standards	4:3B-11

Before you start

About the Low Rise Housing Diversity Code

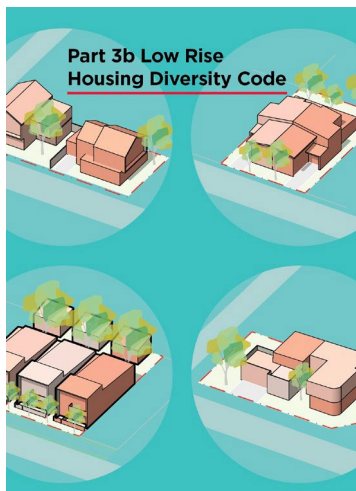

The Low Rise Housing Diversity (LRHD) Code allows for a diverse range of one and two storey homes which provide all the amenity of a traditional free standing home in a well-designed and compact form.

It helps housing affordability by providing smaller homes on smaller lots that still provide all the amenities of a single dwelling and can accommodate a wide variety of lifestyles and needs, including growing families or empty nesters.

LRHD Design Guide and design verification

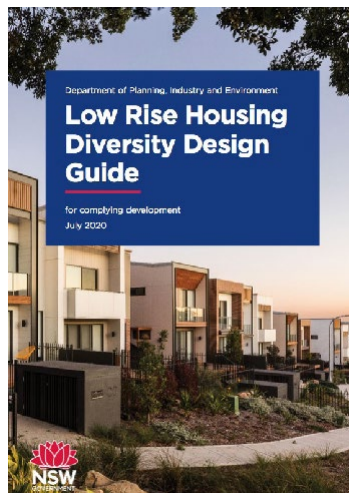

The process to prepare a CDC application under this Part of the Codes SEPP differs to the other Codes in this Guide.

While developments still need to general requirements and the development standards, there is an additional 'design verification' step that is required to be completed.

The [LRHD Design Guide](#) contains objectives and design criteria that must be met and verified in order for approval. The design verification must be prepared by an architect or building designer that is accredited by the Building Designers Association of Australia.

An architect or a building designer that is accredited by the Building Designers Association of Australia is required to certify that the design of the development is consistent with the design criteria in the design verification statement.

In order to avoid duplication or confusion refer to the Low Rise Housing Diversity Design Guide for all development standards and design criteria for Part 3B.

What is complying development under this code?

For works to be complying development under Part 3B Low Rise Housing Diversity Code of the Codes SEPP the proposed works must be for:

- The erection of a 1 or 2 storey dual occupancy, terrace house, or manor house development

The site must meet the following requirements:

- be zoned R1, R2, R3, or RU5
- must have lawful access to a public road
- the minimum lot size under the LEP or where not stated in the LEP, as stated in the Codes SEPP
- must be permissible under the LEP

What is not complying development under this code?

Exclusions to complying development under Part 3B of the Codes SEPP include:

- the erection or alteration of, or an addition to, a roof terrace on the top most roof of a building
- development that is complying development under the Housing Alterations Code
- development on a battle-axe lot
- development on any lot on which there is a secondary dwelling or group home whether or not the development is attached to the dwelling or home
- the erection of a building over a registered easement
- the alteration of, or an addition to, a garage or carport that is located forward of the building line
- the erection of multi dwelling housing (terraces) on bush fire prone land
- development that is in-fill affordable housing, unless it is development that is being carried out by or on behalf of the NSW Land Housing Corporation
- development on unsewered land
- development on land identified as being susceptible to landslide risk

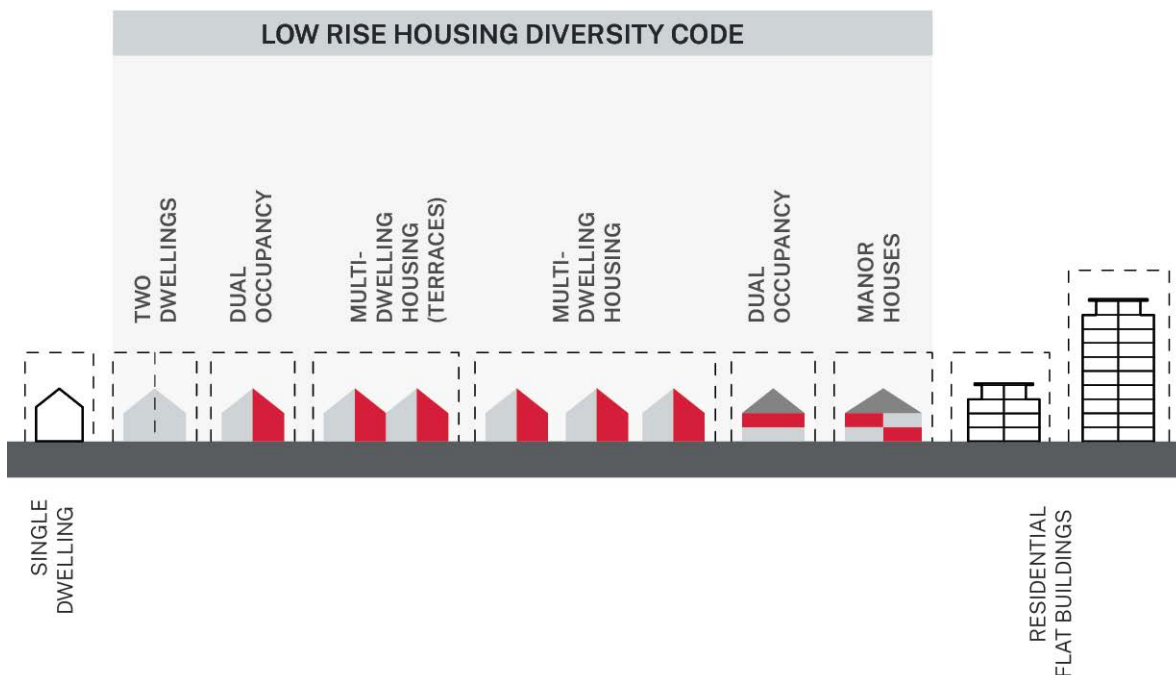

Subdivision

The subdivision of low rise housing may also be carried out as complying development, if certain development standards in the Low Rise Housing

Diversity Code and design criteria in the Low Rise Housing Design Guide are met.

Torrens title is available for dual-occupancies and terraces, provided there is no basement car parking.

Strata subdivision may be possible for dual-occupancies, manor houses, and terraces.

Keep in mind that subdivision is only permitted where the local council LEP allows subdivision.

Development under the Low Rise Housing Diversity Code and the Low Rise Housing Diversity Design Guide does not include development on battle-axe lots or the creation of new battle-axe lots. Each new dual occupancy or terrace house must have a frontage to a public road.

[Part 6](#) of the Codes SEPP contains the development standards for Subdivision. Part 6 is for development under Part 3B of the Codes SEPP only.

Dual occupancies (side by side)

Description

Dual occupancy (attached) means 2 dwellings on one lot of land that are attached to each other but does not include a secondary dwelling.

Dual occupancy (detached) means 2 detached dwellings on one lot of land but does not include a secondary dwelling.

Minimum lot size:

- as specified for a dual occupancy under the relevant council LEP, or
- if none specified, 400m²

Note:

- Dual occupancies must be permitted with consent in the LEP
- Some LEPs have conditions that need to be satisfied in order for the dual occupancy to be permitted

Development Standards Summary Table: Dual occupancies



DUAL OCCUPANCY (SIDE BY SIDE)



DUAL OCCUPANCY (SIDE BY SIDE)

Dual occupancies (side by side)

Development standards

The development standards summary tables provide details on the key controls only in the relevant Codes SEPP. Refer to the specific clauses in the Codes SEPP for further detail and Part 4 of this Guide for explanatory guidance.

Development standard	Dual occupancies (side by side)	
Permissibility 3B.1 (3)	Permitted in R1, R2, R3 and RU5 zones. Dual occupancies will be permitted where the dual occupancies are permitted under the relevant council Local Environmental Plan (LEP).	
Minimum lot size 3B.8 (1)	minimum lot size specified for dual occupancies in a LEP, or 400m ² , if no minimum lot size specified in LEP.	
Minimum lot width 3B.8 (2)	15m (measured at the building line) or where the lot only has vehicular access from a secondary road, parallel road or lane: 12m.	
Maximum building height 3B.9	8.5m	
Maximum gfa (all buildings) 3B.10	Lot area	Maximum GFA
	400m ² -2,000m ²	25% of parent lot area + 300m ²
	>2,000m ²	800m ²
Minimum landscaped area 3B.15	<ul style="list-style-type: none"> • 50% of parent lot area minus 100m² • 25% of area forward of building • At least 50% of the required landscaped area must be provided behind the building line • 1.5m minimum length and width 	
Car parking 3B.18	At least one off-street parking space for each dwelling	
Subdivision	<p>Torrens title subdivision is only allowed for dual occupancies if the Council allows subdivision in its LEP.</p> <p>Torrens title subdivision is permitted under the Code and the minimum lot size of each resulting lot must be:</p> <ul style="list-style-type: none"> • at least the minimum lot size in the relevant council LEP, or • if the LEP does not specify a minimum lot size, it is 200m². <p>If strata subdivision for dual occupancies is permitted under the relevant council LEP, then the strata subdivision of the dual occupancy is permitted under the Code.</p> <p>In the case of a dual occupancy where no part of the a dwelling is located above any part of another dwelling, the strata area (being the area of the ground floor of all dwellings) is not less than 180m².</p> <p>Dual occupancy development and subdivision may be approved concurrently under one complying development certificate.</p> <p>(Subdivision can only occur where an occupation certificate for any new building or part of a building to which the Code relates has been obtained.)</p>	

Manor houses and dual occupancies (one above the other)

Manor houses

Means a residential flat building containing 3 or 4 dwellings, where:

- each dwelling is attached to another dwelling by a common wall or floor, and
- at least 1 dwelling is partially or wholly located above another dwelling, and
- the building contains no more than 2 storeys (excluding any basement)

Minimum lot size:

- as specified for a manor house under the relevant council LEP, or
- if none specified, 600m²

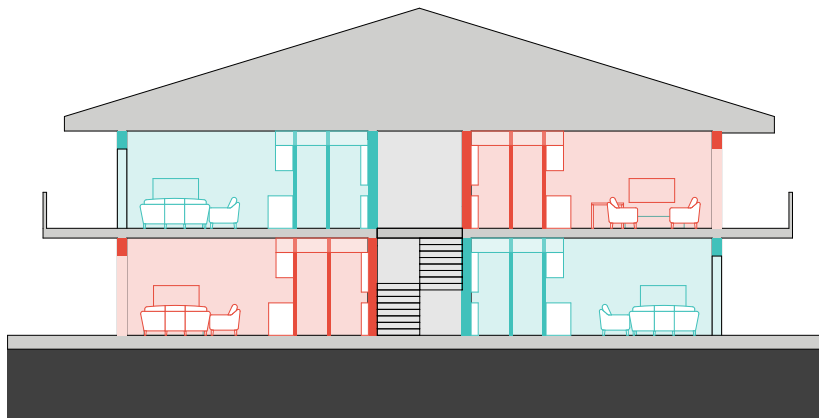

MANOR HOUSES

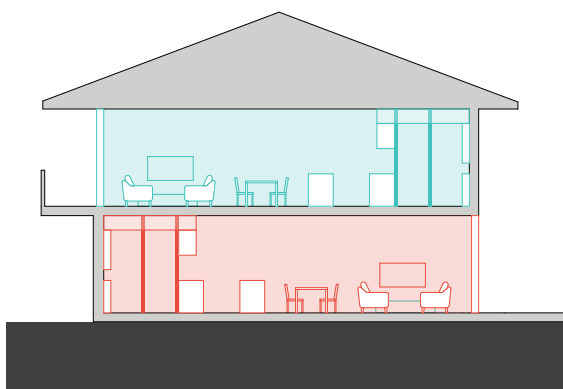

DUAL OCCUPANCY (ONE ABOVE THE OTHER)

Dual occupancy (one above the other)

Dual occupancy (attached) means two dwellings on one lot of land where part of a dwelling is located above part of another dwelling but does not include a secondary dwelling.

Minimum lot size:

- as specified for a dual occupancy under the relevant council LEP, or
- if none specified, 400m²

Manor houses and dual occupancies (one above the other)

Development standards

The development standards summary tables provide details on the key controls only in the relevant Codes SEPP. Refer to the specific clauses in the Codes SEPP for further detail and Part 4 of this Guide for explanatory guidance.

Development standard	Manor houses and dual occupancies (one above the other)	
Permissibility 3B.1(3)	Permitted in R1, R2, R3 and RU5 zones. Manor houses will be permitted where either multi-dwelling housing or residential flat buildings are permitted under the relevant environmental planning instrument. Dual occupancies will be permitted where dual occupancies (attached) are permitted under the relevant environmental planning instrument (EPI) such as an LEP.	
Minimum lot size 3B.21(a) 3B.21(b)	Manor houses: minimum lot size specified for dual occupancies in a LEP, or 400m ² , if no minimum lot size specified in LEP	
Minimum lot width 3B.21(c)	15m (measured at building line)	
Maximum building height 3B.22	8.5m	
Maximum gfa (all buildings) 3B.23	25% of the lot area + 150m ² to a maximum of 400m ²	
Minimum landscaped area 3B.27	50% of the lot area minus 100m ² , 25% of area forward of building, and at least 50% of the area of the lot behind the building line must be landscaped 1.5m minimum length and width	
Car parking 3B.30	One off-street parking space for each dwelling	
Concurrent subdivision 6.1(2)	Strata subdivision of manor houses is permitted under the Code. If strata subdivision for dual occupancies is permitted under the relevant EPI, then the strata subdivision of the dual occupancy is permitted under the Code (Subdivision can only occur where an occupation certificate for any new building or part of a building to which this Code relates has been obtained.)	
Primary road setback 3B.24(1), (2) and (3)	Where existing residential accommodation is on the same side of the road and within 40m of the development – average of the two nearest residential accommodation buildings. If no residential accommodation is within 40m of the development then:	
	Lot area	Setback
	400m ² -900m ²	4.5m
	900m ² -1,500m ²	6.5m
>1,500m ²	10m	

Development standard	Manor houses and dual occupancies (one above the other)		
Side setbacks 3B.24 (4) and 5	<p>A manor house or a dual occupancy (one above the other) must have a minimum side setback of 1.5m.</p> <p>For any part of a manor house or dual occupancy (one above the other) that is more than 10m behind the building line and is more than 4.5m above the existing ground level, the minimum side boundary setback is:</p> <p>$s = h - 3m$ where,</p> <p>'s' is the minimum setback in metres, and</p> <p>'h' is the height of the part of the building in metres.</p>		
Rear setbacks 3B.24 (6)	Lot area	Building height	Minimum setback
	400m ² -1,500m ²	0m-4.5m	6m
	>1,500m ²	0m-4.5m	10m
	400m ² -1,500m ²	>4.5m	10m
	>1,500m ²	>4.5m	15m

Multi dwelling housing (terraces)

Development standards

The development standards summary tables provide details on the key controls only in the relevant Codes SEPP. Refer to the specific clauses in the Codes SEPP for further detail and Part 4 of this Guide for explanatory guidance.

Development standard	Multi dwelling housing (terraces)	
Permissibility 3B.1 (3)	Permitted in R1, R2, R3 and RU5 zones. Multi dwelling housing (terraces) will be permitted where multi dwelling housing is permitted under the relevant council LEP.	
Minimum lot size 3B.33 (1)	Minimum lot size specified for multi dwelling housing in a LEP, or Minimum lot size specified for multi dwelling housing (terraces) in a LEP, or 600m ² , if no minimum lot size specified in LEP. Minimum lot size must not be less than 600m ² .	
Minimum lot width 3B.33 (2)	21m (measured at the building line)	
Maximum building height 3B.34	9m	
Maximum gfa (all buildings) 3B.35	Zone	Maximum GFA
	R1, R2 and RU5	60% of lot area
	R3	80% of lot area
Minimum landscaped area 3B.40	Zone	Landscaped area
	R1, R2 and RU5	Where concurrent subdivision is proposed: The minimum area that must be provided for each resulting lot - 30% of lot area. Where no subdivision is proposed: The minimum landscaped area that must be provided is 30% of the parent lot area of which at least 54m ² is to be allocated to each dwelling.
	R3	Where concurrent subdivision is proposed: The minimum area that must be provided for each resulting lot - 20% of lot area. Where no subdivision is proposed: The minimum landscaped area that must be provided is 20% of the parent lot area of which at least 36m ² is to be allocated to each dwelling.
Car parking 3B.43	At least one off-street parking space for each dwelling.	

Development standard	Multi dwelling housing (terraces)		
Concurrent subdivision 6.4 (Torrens) 6.2 (2) (Strata)	<p>Torrens title subdivision is permitted under the Code to a minimum of 200m² for each lot (terrace).</p> <p>Multi dwelling housing (terraces) are permitted to be strata subdivided, this may occur in instances where basement parking or common areas are provided. The strata area of a dual occupancy is not less than 180m².</p> <p>Multi dwelling housing (terraces) development and subdivision may be approved concurrently under one complying development certificate.</p> <p>(Subdivision can only occur where an occupation certificate for any new building or part of a building to which this Code relates has been obtained.)</p>		
Primary road setback 3B.36 (1), (2) and (3)	<p>Where existing dwelling houses, dual occupancies or multi dwelling housing (terraces) in R1, R2 or RU5 zones are on the same side of the road and within 40m of the development – average of the two nearest dwelling houses, dual occupancies or multi dwelling housing (terraces).</p> <p>If no dwelling houses, dual occupancies or multi dwelling housing (terraces) are within 40m or are located in a R3 zone – 3.5m.</p>		
Side setbacks 3B.36 (4)	Multi dwelling housing (terraces) must have a minimum side setback of 1.5m.		
Rear setbacks 3B.36 (5)	Lot area	Building height	Minimum setback
	600m ² -900m ²	0m-4.5m	3m
	600m ² -900m ²	>4.5m	8m
	>900m ² -1,500m ²	0m-4.5m	5m
	>900m ² -1,500m ²	>4.5m	12m
	>1,500m ²	0m-4.5m	10m
	>1,500m ²	>4.5m	15m

Part 3C Greenfield Housing Code

Summary of key development standards

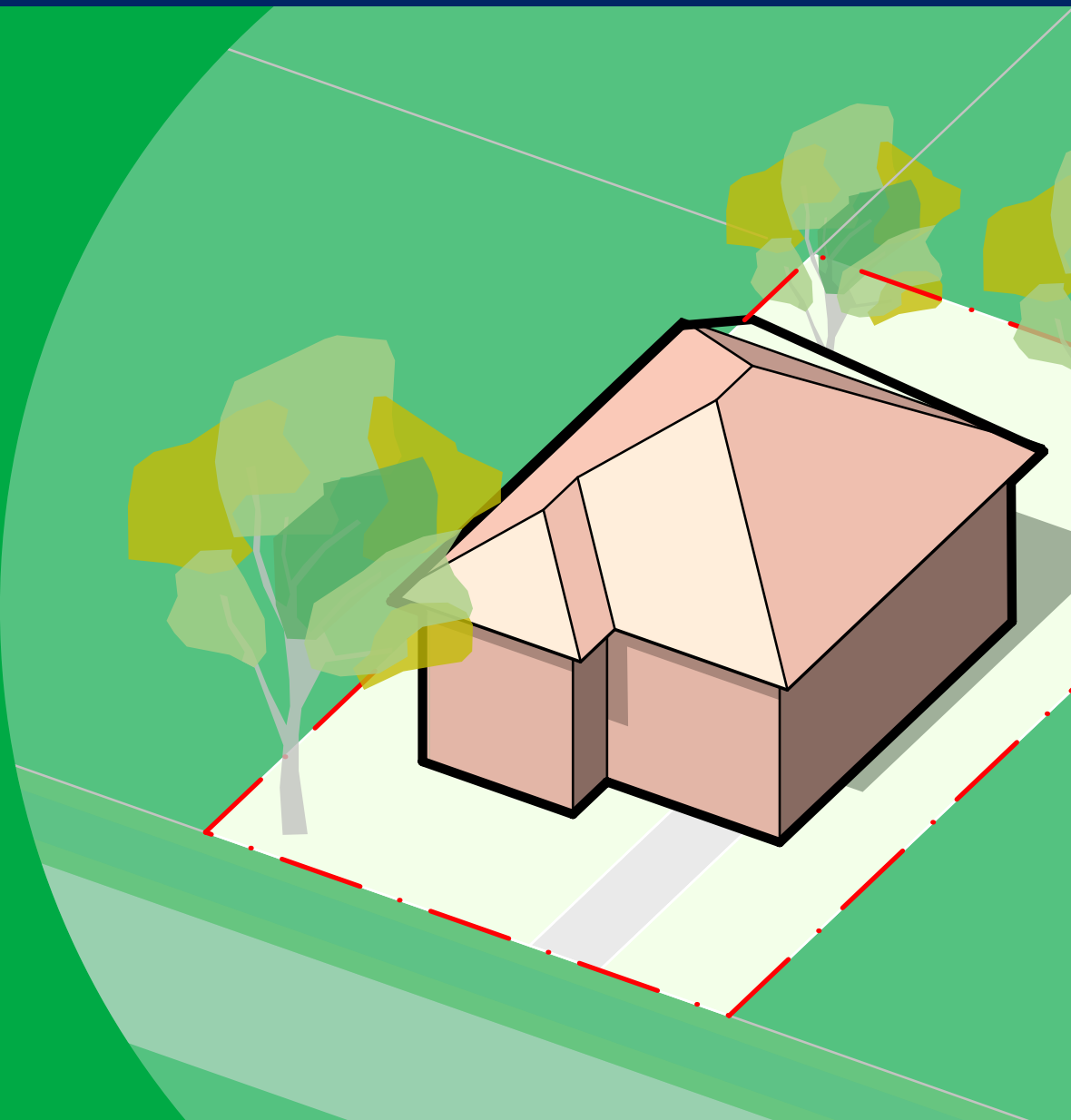

Before you start

What is complying development under this code?

For works to be complying development under Part 3C Greenfield Housing Code of the Codes SEPP the proposed works must be:

- identified as being located in a Greenfield Housing Code area
- for the erection, alteration or addition to any 1 or 2 storey dwelling house or any attached development
- for erection, alteration or addition of any detached development

The site must meet the following requirements:

- located in zone R1, R2, R3, R4 or RU5,
- be at least 200m² in size
- be at least 6m wide (as measured at the building line)
- be at least 25m deep
- only result in 1 dwelling house on the lot at the completion of the development
- have lawful access to a public road at completion of the development
- if the development is on a battle-axe lot – the lot must be at least 12m by 12m (not including the access laneway) and must have an access laneway that is at least 3m wide
- if the development is on a corner lot – the width of the primary road boundary of the lot must be at least 6m

Secondary dwellings (e.g. granny flats)

A secondary dwelling with a separate development or complying certificate consent does not count towards the limit of 1 dwelling house per site.

This code does not apply to secondary dwellings. Refer to the [Housing SEPP](#) for complying development standards for secondary dwellings (e.g. granny flats).

What is not complying development under this code?

For works to be complying development under Part 3C Housing Code of the Codes SEPP the works must not be for:

- the erection, alteration or addition to, a roof terrace on the topmost roof of a building
- development that is complying development under the Housing Alterations Code
- development that is attached to a secondary dwelling or group home
- the erection of a building over a registered easement
- the erection of a common wall
- the alteration of, or an addition to, a garage or carport that is located forward of the building line
- the construction of a basement that will have an area that exceeds the limits shown in the table below:

Lot width	Maximum basement area
6-10m	25m ²
>10m	45m ²

Bushfire prone land

[Clause 3C.5](#)

For land that is bushfire prone, but permissible under Clause 1.19A of the Codes SEPP (and as detailed in Step 3.4 of this Guide), additional development controls are required.

Refer to [clause 3C.5](#) for the detailed requirements.

Flood control lots

[Clause 3C.6](#)

For land that is flood prone, but not high hazard or high risk (and as detailed in Step 3 of this Guide), complying development may be possible provided additional criteria are met.

Refer to [clause 3C.6](#) for the detailed requirements.

Summary of key development standards

The development standards summary tables provide details on the key controls only in the relevant Codes SEPP. Refer to the specific clauses in the Codes SEPP for further detail and Part 4 of this Guide for explanatory guidance.

Development standards (based on lot area)

Lot Size	200 - 250m ²	250 - 300m ²	300 - 350m ²	350 - 450m ²	450 - 560m ²	560 - 600m ²	600 - 740m ²	740 - 900m ²	900 - 920m ²	920 - 1,000m ²	1,000 - 1,500m ²	+1,500m ²
All developments												
Combined lot floor area 3C.10	78%	75%	235m ²	25% lot area + 150m ²	290m ²	25% lot area + 150m ²	335m ²	25% lot area + 150m ²	380m ²	25% lot area + 150m ²	400m ²	
Parallel road setback 3C.11 (9) 3C.12 (6) 3C.29 (4)	3m <3m for certain attached developments for a maximum of 50% width of rear boundary if parallel road is not classified											
Minimum landscape 3C.15, 3C.30	10%	15%	20%	30%	40%	45%						
Dwelling house and attached developments												
Maximum storeys 3C.2	2											
Height 3C.9	8.5m											
Primary road setback 3C.11 (1)	3m & 1.5m from the articulation zone	4.5m and 3m from the articulation zone										
Rear setback C.11 (7)	Height of dwelling or attached development more than 4.5m								Minimum setback from rear 6m			
Classified road setback 3C.11 (10)	the greater of 9m or as noted in planning instrument											
Public reserve setback 3C.11 (11)	3m											
Front setback (battle axe lot) 3C.11 (12)	3m											

Lot Size	200 -250m ²	250 -300m ²	300 -350m ²	350 -450m ²	450 -560m ²	560 -600m ²	600 -740m ²	740 -900m ²	900 -920m ²	920- 1,000m ²	1,000 - 1,500m ²	+1,500m ²
Rear lane setback (excl. Garages) 3C.12 (5)	<0.9m for a maximum of 50% width of the rear boundary for lots adjoining a laneway											
Additional standards - detached developments (excluding studios)												
Maximum building height 3C.21	4.5m											
Floor area 3C.23	35m ²	45m ²				60m ²			100m ²			
Primary & secondary road setback 3C.24 (1)	Behind building line (except detached garages & carports. Refer to Clause 3C.26)											
Rear setback 3C.24 (8)	0.9m						1.5m			2.5m		
Secondary road setbacks (garages or carports) 3C.26 (7)	2m					3m			5m			
Additional standards - detached developments (studios)												
Building height 3C.28 (2)	4.5m or, 6m if the studio is within 0.9m of a lane and above a garage											
Floor area 3C.28 (3)	20m ²	36m ²										

Development standards (based on lot width)

Lot width	6-7m	7-10m	10-15m	15m+
All developments				
Basement area 3C.3	25m ²		45m ²	
Side setbacks 3C.11 (2)	Ground level			
	Side A: 0m Side B: 0m	Side A: 0m Side B: 0.9m	Side A: 0m Side B: 0.9m	Side A: 0.9m Side B: 0.9m
	Upper Level			
	Side A: 1.2m Side B: 0m	Side A: 1.2m Side B: 0.9m	Side A: 1.2m Side B: 0.9m	Side A: 1.2m Side B: 0.9m
Secondary road setback 3C.11 (8)	1m	2m		
Minimum landscape forward of building line 3C.15 (3) , 3C.30	25%			15-18m: 25% 18m+ 50%
Trees 3C.37 (4)	Front yard: a tree with mature height of 5m+ Rear yard: a tree with a mature height of 8m+			
Car parking 3C.19 (1)	not required	1 space required for lot width >8m	1 space required	1 space required
Carport/garage primary road setback 3C.19 (5)	Primary Road setback <4.5m: 5.5m minimum Primary Road setback 4.5m+: at least 1m behind the building line			
Maximum garage door openings to primary road 3C.19 (6)	Single storey dwelling			
	N/A (as garage to primary road not permitted)	3.2m	10-11m: 3.2m 11-15m: 6m	50% of facade width to maximum 7.2m
	Two storey dwelling			
	N/A	3.2m	10-11m: 6m 11-15m: 6m	50% of facade width to maximum 7.2m
Additional standards - detached developments (excluding studios)				
Rear lane setback (garages) 3C.13	0m		0m for maximum 6.5m length	0m for maximum 9m length
Side setbacks 3C.24 (2)	0.9m			15-18m: 0.9m 18-24m: 1.5m 24m+: 2.5m

Development standards (general)

Additional standards	
Setback exceptions 3C.12	Setbacks do not apply to certain building elements such as access ramps, driveways, and paving. Encroachments within the required setbacks are also permitted in certain instances for minor building elements.
Attached garages 3C.13	Additional standards apply for attached garages.
Outdoor entertainment areas 3C.14	These standards apply to attached balconies, decks, patios, pergolas, terraces and verandahs
Building design 3C.16	Controls for the location and number of windows and doors, design features, and allowable encroachments into articulation zones.
Windows, doors, and openings 3C.17	No wall within 900mm of a side boundary may have a window, door, or any other opening.
Privacy screens 3C.18	Privacy screens must be provided in certain situations. Refer to 3C.18 and Part 4 of the Guide
Heritage conservation areas 3C.25	Detached developments on lots adjoining lanes, secondary roads, or parallel roads are not permissible in heritage conservation areas or draft heritage conservation areas Detached developments adjoining other lots must be: Located behind the building line of the dwelling house No closer to side boundaries than the dwelling house Gross floor area of <20m ²
Detached studios 3C.28	Additional development standards apply for detached studios that vary to those for other detached developments.
Swimming pools 3C.31	Controls for the design and placement of swimming pools. Refer to 3C.31 and Part 4 of the Guide. Pools must comply with the BCA and Australian Standards for pool and pool fencing.
Fences 3C.32	Controls for the design and placement of fences. Refer to 3C.32 and Part 4 of the Guide.
Earthworks 3C.33	Controls for excavation, fill and retaining walls. Additional development standards outline when professional input is required.
Drainage 3C.34	Stormwater must be directed by a gravity fed system to: a public drainage system an inter-allotment drainage system an on-site disposal system
Protecting adjoining walls 3C.35 , 3C.17	Any wall built within 900mm of a boundary requires a professional engineer's report.
Protected trees 3C.36	Controls for pruning and removing trees, and protected trees. Refer clause 3C.36 and Part 4 of the Guide for guidance.

Part 3D

Inland Housing Code

Summary of key development standards



Before you start

Determining division type

The Inland Code is divided into separate divisions depending on the development type and zoning.

There are separate development standards for each type within the Codes SEPP and as summarised in the tables in this Guide.

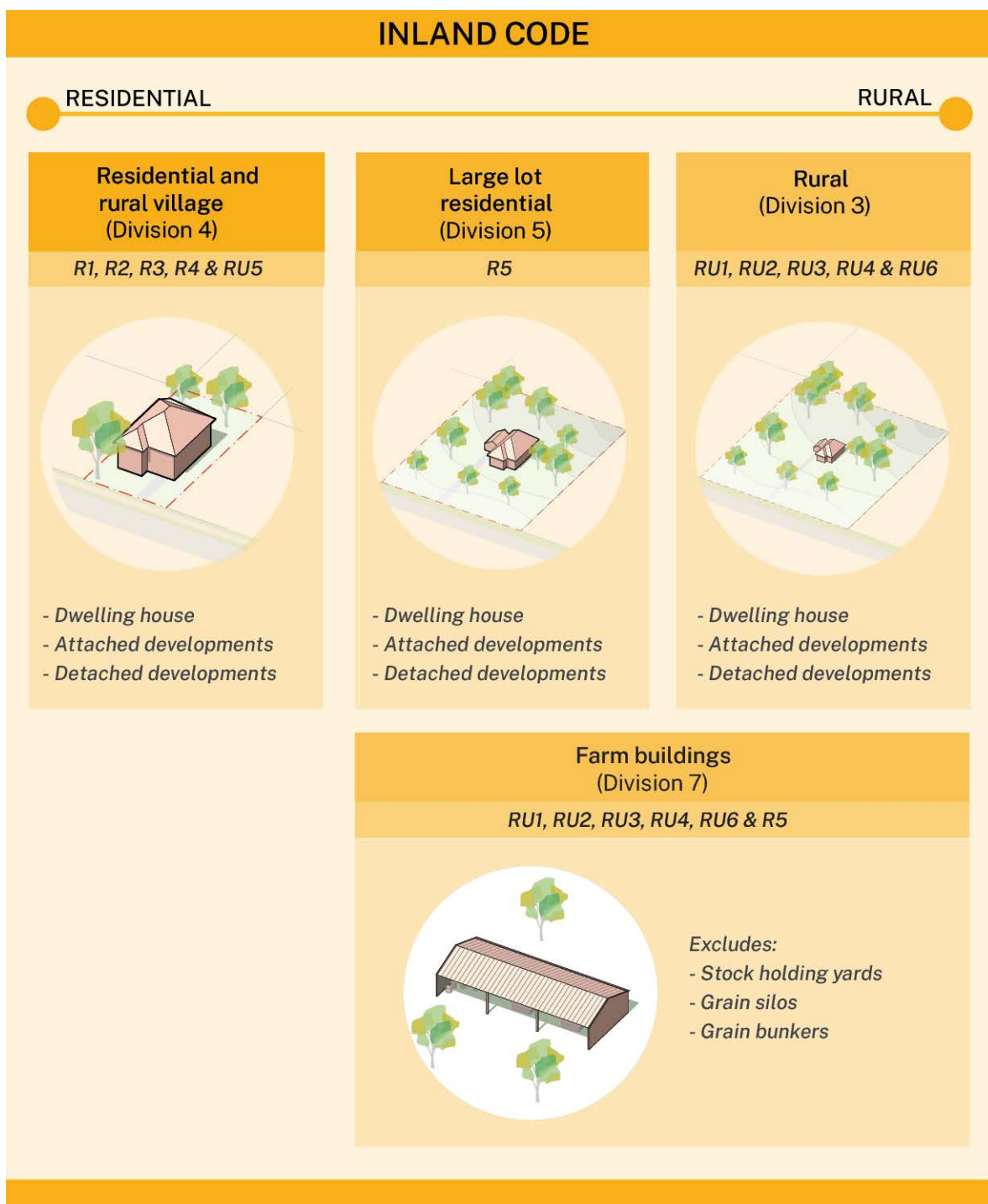

What is complying development under this code?

For works to be complying development under Part 3D Inland Code of the Codes SEPP the proposed works must be for:

- the erection, alteration or addition to any 1 or 2 storey dwelling house or any attached development
- erection, alteration or addition of any 1 or 2 storey detached development
- erection, alteration or addition to a farm building

Note: basements are not counted as storeys.

The site must meet the following requirements:

- located in the inland local government area, and
- located in zone RU1, RU2, RU3, RU4, RU5, RU6, R1, R2 R3, R4 and R5, and
- have lawful direct frontage access or a right of carriageway to a public road

Bushfire prone land

[Clause 3D.6](#)

For land that is bushfire prone, but permissible under clause 1.19A of the Codes SEPP (and as detailed in Step 3.4 of this Guide), additional development controls are required.

Refer to [clause 3D.6 for the detailed requirements](#).

Flood control lots

[Clause 3D.7](#)

For land that is flood prone, but not high hazard or high risk (and as detailed in Step 3 of this Guide), complying development may be possible provided additional criteria are met.

Refer to [3D.7 for the detailed requirements](#).

What is not complying development under this code?

Exclusions to complying development under Part 3D of the Codes SEPP include:

- the erection or alteration of, or an addition to a roof terrace on the top most roof of a building
- development that is complying development under the Housing Alterations Code
- development on any lot on which there is a secondary dwelling or group home
- the erection of a building over a registered easement
- erection of a building within 1m of a public water or sewer mains
- the erection of a new dwelling house on land in Zone RU3
- the erection of a common wall
- the alteration of, or addition to a garage or carport that is forward of the building line
- development that penetrates any obstacle limitation surfaces (see clause for details)
- development on land shown on any relevant Procedures for Air Navigation Services (see clause for details)
- the construction of a basement in zone R1, R2, R3, R4, or RU5 that will exceed the area table below:

Lot width	Maximum basement area
6-10m	25m ²
>10m	45m ²

Siding Spring Observatory

[Clause 3D.8](#)

Additional criteria for external lights must be met on dwellings in the Coonamble, Gilgandra, Warrumbungle Shire and part of Dubbo Regional local government areas.

These criteria protect the dark sky area around the Siding Spring Observatory.

Refer to [clause 3D.8 for the detailed requirements](#).

Residential and rural village

Application

[Clause 3D.17](#)

Works under this section of the code apply to the erection, alteration or addition to any dwelling house, any attached or detached development,

Development standards for residential and rural lots (Division 4) apply only to land zoned R1, R2, R3, R4 and RU5.

Lot requirements

[Clause 3D.18](#)

Lot requirements:

- be at least 200m² in size
- be at least 6m wide (as measured at the building line)
- only result in 1 dwelling house on the lot at the completion of the development
- if the development is on a battle-axe lot – the lot must be at least 12m by 12m (not including the access laneway) and must have an access laneway that is at least 3m wide
- if the development is on a corner lot – the width of the primary road boundary of the lot must be at least 6m

Refer to [clause 3D.18](#) for the detailed requirements.

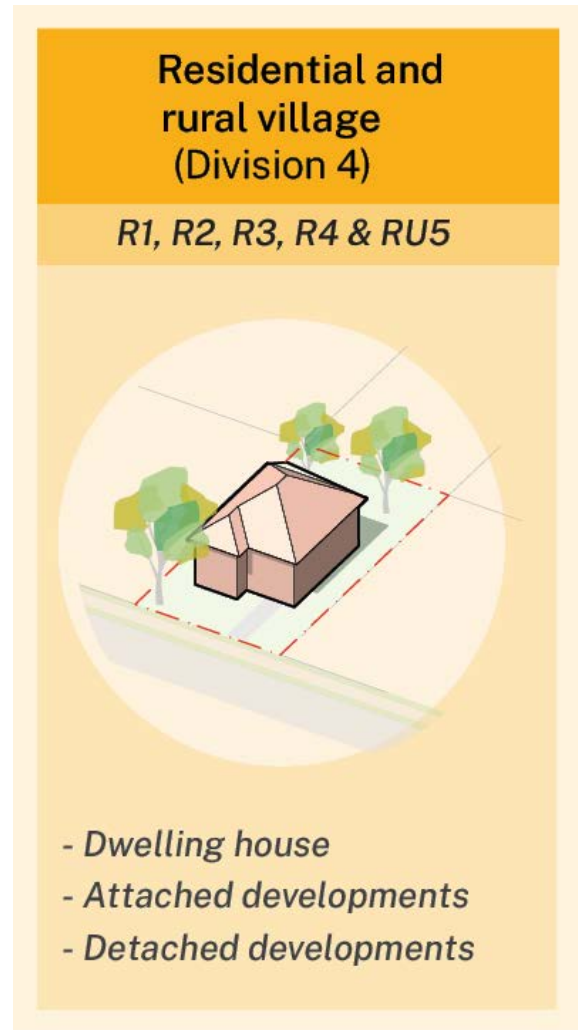

Residential and rural village

Development standards (based on lot area)

The development standards summary tables provide details on the key controls only in the relevant Codes SEPP. Refer to the specific clauses in the Codes SEPP for further detail and Part 4 of this Guide for explanatory guidance.

Lot Size	200 -250m ²	250 -300m ²	300 -350m ²	350 -450m ²	450 -560m ²	560 -600m ²	600 -740m ²	740 -900m ²	900 -920m ²	920- 1,400m ²	1,400 - 1,500m ²	+1,500m ²
All developments												
Combined lot floor area 3D.20	78%	75%	235m ²	25% lot area + 150m ²	290m ²	25% lot area + 150m ²	335m ²	25% lot area + 150m ²	380m ²	25% lot area + 150m ²	500m ²	
Parallel road setback 3D.21 (15)	3m. <0.9m for a maximum of 50% width of the rear boundary for lots adjoining a laneway <3m for certain attached developments for a maximum of 50% width of rear boundary if parallel road is not classified											
Minimum landscape 3D.24	10%		15%		20%		30%		40%		45%	
Dwelling house and attached developments												
Maximum storeys 3D.3	2											
Height 3D.19	8.5m											
Primary road setback 3D.21 (1)	Greater than the average primary road setback of the 2 nearest dwelling houses on the same side of the road.											
Primary road setback 3D.21 (3)	Where there is not 2 dwelling houses within 40m of the lot on the same side of the primary road											
	3m or average		4.5m or average								10m or average	
Secondary road setback 3D.21 (4)	2m						3m			5m		
Classified road setback 3D.21 (5)	the greater of 9m or as noted in planning instrument											
Rear setback 3D.21 (14)	<4.5m high = 3m		<4.5m high = 3m						<4.5m high = 5m		<4.5m high = 10m	
	>4.5m high = 10m or average neighbours		>4.5m high = 8m						>4.5m high = 12m		>4.5m high = 15m	

Residential and rural village

Lot Size	200 - 250m ²	250 - 300m ²	300 - 350m ²	350 - 450m ²	450 - 560m ²	560 - 600m ²	600 - 740m ²	740 - 900m ²	900 - 920m ²	920 - 1,400m ²	+1,500m ²
Public reserve setback 3D.21 (16)	3m										
Front setback (battle axe lot) 3D.21 (17)	3m										
Additional standards - detached developments (excluding studios)											
Maximum building height 3D.41	4.8m										
Floor area 3D.43	36m ²			45m ²			60m ²		100m ²		
Primary and secondary road setback (ex garages and carports) 3D.44 (1)	Behind building line or 50m if dwelling house setback more than 50m from a primary or secondary road.										
Rear setback (ex garages and carports) 3D.44 (8)	0.9m							1.5m		2.5m	
Primary road setbacks (garages or carports) 3D.46 (5)	5.5m minimum and at least 1m behind the building line										
Secondary road setbacks (garages or carports) 3D.46 (6)	2m						3m			5m, or 10m for lots more than 4,000m ²	
Rear setbacks (garages or carports) 3D.46 (7)	0.9m							1.5m		2.5m	
Additional standards - detached developments (studios)											
Building height 3D.48 (2)	4.8m or, 6m if the studio is within 0.9m of a lane										
Floor area 3D.48 (3)	20m ²			36m ²							

Refer to relevant section in this Guide for detailed requirements and further information on each of the development standards.

Residential and rural village

Development standards (based on lot width)

Lot width	6-18m	8-10m	10-12.5m	12.5-18m	18-24m	+24m
All developments						
Basement area 3D.4	25m ²	45m ²				
Side setback 3D.21 (7) 3D.21 (8)	up to 4.5m = 0.9m above 4.5m = building height - 3m	up to 4.5m = 1.5m above 4.5m = building height - 3m			up to 4.5m = 2.5m above 4.5m = building height - 3m or 2.5m (whichever is greater)	
Maximum built to boundary wall height 3D.21 (11)	3.3m or not higher than neighbouring built to boundary wall			Not permitted		
Maximum built to boundary wall length 3D.21 (12)	20m, or 50% of lot depth, or length of neighbouring built to boundary wall		10m or length of neighbouring built to boundary wall	Not permitted		
Maximum built to side boundary walls 3D.21 (9-10)	may build to both sides (subject to conditions)		may build to one side (subject to conditions)		Not permitted	
Minimum landscape forward of building line 3D.24 (3)	25%				50%	
Landscape area: rear setback 3D.24 (3)	50% of landscaped area must be located behind the building line to the primary road boundary					
Car parking 3D.27 (1)	not required		1 space required			
Carport/ garage primary road setback 3D.27 (2)	5.5m minimum and at least 1m behind the building line					

Residential and rural village

Lot width	6-18m	8-10m	10-12.5m	12.5-18m	18-24m	+24m
Maximum garage door openings 3D.27 (6-7)	3.2m, only if accessed from a rear lane	3.2m	3.2m for lots less than 12m wide. 6m for lots wider than 12m	6m	6m	9.2m, if one garage door is set back at least 1m behind the other garage doors
Additional standards - detached developments (studios)						
Side and rear setbacks 3D.48 (4)	0.9m				1.5m	

Refer to relevant section in this Guide for detailed requirements and further information on each of the development standards.

Additional standards	
Lot requirements 3D.18	Lot requirements: be at least 200m ² in size be at least 6m wide (as measured at the building line) only result in 1 dwelling house on the lot if the development is on a battle-axe lot – the lot must be at least 12m by 12m (not including the access laneway) and must have an access laneway that is at least 3m wide if the development is on a corner lot – the width of the primary road boundary of the lot must be at least 6m
Setback exceptions 3D.22	Setbacks do not apply to certain building elements listed in clause 3D.22 such as downpipes, driveways, and paving.
Outdoor entertainment areas 3D.23	Development standards apply to outdoor living areas to minimise potential impacts on neighbouring properties. Standards applies to attached balconies, decks, patios, pergolas, terraces and verandahs. Refer to clause 3D.23 for detailed requirements.
Building design 3D.25	Controls for the location and number of windows and doors, design features, and allowable encroachments into articulation zones.
Privacy screens 3D.26	Privacy screens must be provided in certain situations. Refer to 3D.26 and Part 4 of the Guide
Car parking and access 3D.27	At least one car parking space is required for new dwellings unless the lot is less than 8m. Development standards are established to minimise the visual impact of a garage on the streetscape. This includes minimum setbacks from the dwelling and street and maximum openings proportion to the lots width.
Detached developments 3D.40-49	Additional development standards apply for detached developments that vary to those for other detached developments.

Large lot residential

Application [Clause 3D.28](#)

Works under this section of the code apply to the erection, alteration or addition to any dwelling house, any attached or detached development.

Development standards for large lot residential (Division 5) apply only to land zoned R5.

Lot requirements

[Clause 3D.29](#)

Lot requirements:

- not be less than the area as specified by council or if no size is specified be at least 800m² in size
- be at least 18m wide (as measured at the building line)
- only result in 1 dwelling house on the lot at the completion of the development
- if the development is on a battle-axe lot – the lot must be at least 12m by 12m (not including the access laneway) and must have an access laneway that is at least 3m wide
- if the development is on a corner lot – the width of the primary road boundary of the lot must be at least 18m

Refer to [clause 3D.29](#) for the detailed requirements.

Siting of development

[Clause 3D.30\(2\)](#)

On large lots (greater than 4ha), development standards are established that locate buildings away from and below ridgelines, so that development does not dominate prominent ridgelines.

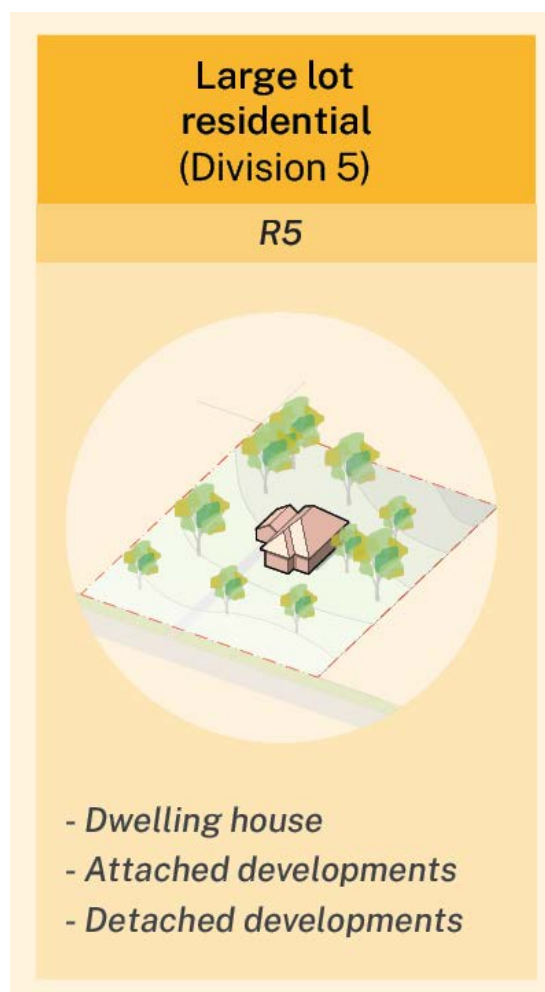
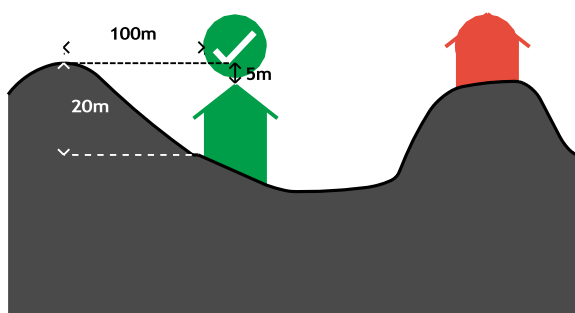

Large lot residential

Development standards (based on lot size)

The development standards summary tables provide details on the key controls only in the relevant Codes SEPP. Refer to the specific clauses in the Codes SEPP for further detail and Part 4 of this Guide for explanatory guidance.

Development standard	Lot area (m ²)		
	<1,000	1,000 - 4,000	4,000 +
All developments			
Siting 3D.30(2)	Siting controls apply to lot greater than 4ha which may influence the location and height of the building.		
Combined lot floor area 3D.31	500m ²		
Classified road setback 3D.32(7)	The greater of 9m or as noted in the planning instrument.		
Watercourse setback 3D.32 (15)	40m		
Public reserve setback 3D.32 (13)	3m		
Certain adjoining land* setback 3D.32 (12)	250m for certain adjoining land *forestry, intensive livestock agriculture, intensive plant agriculture, mines and extractive industries, railway lines, rural industries.		
Minimum landscape area 3D.35 (1)	45% of lot area	N/A	
Minimum area forward of building line to be landscape 3D.35 (2)	50%		
Minimum landscape dimensions 3D.35 (3)	2.5m		
Building design 3D.36	Articulation requirements apply for setback to primary road less than 10m		
Privacy 3D.37	Applicable to windows, balconies, decks, patios, terraces and verandahs	N/A	
Car parking space 3D.38	1 space required	N/A	
Carport / garage primary road setback 3D.38 (5)	5.5m minimum and at least 1m behind the building line	N/A	

Large lot residential

Development standard	Lot area (m ²)		
	<1,000	1,000 - 4,000	4,000 +
Maximum garage door width 3D.38 (9)	Lot 18-24m: 6m Lot 24m+ = 9.2m (if one garage door is setback at least 1m)		N/A
Triple garages 3D.38 (10)	Lot width 24m+ One garage door set back 1m from the others Max driveway width 6m		
Dwelling house and attached development			
Maximum storeys 3D.3(1)	2		
Maximum building height 3D.30(1)	8.5		10m
Primary road setback 3D.32(1) - (4)	Average of neighbours or 10m		15m
Secondary road setback 3D.32 (5)	5m		10m
Unsealed road setback 3D.32(8)	50m		
Parallel road setback 3D.32 (6)	10m		N/A
Side setback 3D.32 (10)	2.5		10m
Rear setback 3D.32 (11)	8m	10m	15m
Battle-axe front setback 3D.32 (14)	5m		
Rear lane 32.33 (3)	<900mm for a maximum of 50% of the rear boundary length		

Large lot residential

Development standard	Lot area (m ²)		
	<1,000	1,000 - 4,000	4,000 +
Maximum floor level for attached side or rear outdoor spaces* 3D.34 (2)	<3m setback = 2m high 3m-6m setback = 3m high 6m+ setback = 4m high *Balconies, decks, patios, terraces and verandahs		
Maximum floor area for attached or outdoor areas* 3D.34 (3)	12m ² * within 6m of side or rear boundary, and * with a floor area more than 2m above ground level		
Detached development (excluding studios)			
Maximum building height 3D.41	4.8m		
Floor area 3D.43	100m ²		
Primary and secondary road setbacks 3D.44 (1)	Behind building line or 50m if dwelling house setback more than 50m from a primary or secondary road.		
Side setbacks 3D.44 (2)	6m-18m lot: 0.9m* 18-24m lot: 1.5m >24m lot: 2.5m May be built to boundary/s subject to conditions	5m	
Rear setbacks 3D.44 (8)	200m ² -900m ² : 0.9m 900m ² -1,500m ² : 1.5m 1,500m ² -4,000m ² : 2.5m	5m	
Parallel road setback	3m		
Secondary road setbacks (garage or carport)	200m ² -600m ² : 2m 600m ² -1,500m ² : 3m 1,500m ² -4,000m ² : 5m	10m	
Detached development (studios)			
Building height	4.8m* *6m if the studio is within 0.9m of a lane		
Floor area	36m ²		
Side and rear setbacks	2.5m	5m	

Large lot residential

Additional standards	
Setback exceptions 3D.33	Setbacks do not apply to certain building elements listed in clause 3D.33 such as downpipes, driveways, and paving.
Outdoor entertainment areas 3D.34	Development standards apply to outdoor living areas to minimise potential impacts on neighbouring properties. Standards applies to attached balconies, decks, patios, pergolas, terraces and verandahs. Refer to clause 3D.23 for detailed requirements.
Building design 3D.36	Controls for the location and number of windows and doors, design features, and allowable encroachments into articulation zones.
Privacy screens 3D.37	Privacy screens must be provided in certain situations. Refer to 3D.37 and Part 4 of the Guide
Car parking and access 3D.38	For lots less than 4,000m ² at least one car parking space is required for new dwellings. Development standards are established to minimise the visual impact of a garage on the streetscape. This includes minimum setbacks from the dwelling and street and maximum openings proportion to the lots width.
Detached developments 3D.40-49	Additional development standards apply for detached developments that vary to those for other detached developments.

Rural lots

Application

[Clause 3D.9](#)

Works under this section of the code apply to the erection, alteration or addition to any 1 or 2 storey dwelling house or any attached development.

Development standards for Rural Lots (Division 3) apply only to land zoned RU1, RU2, RU3, RU4 and RU6.

Lot requirements

[Clause 3D.10](#)

Lot requirements:

- minimum size as specified under the relevant council LEP, or
- minimum size if none specified; 4,000m²
- only result in 1 dwelling house on the lot at the completion of the development

Refer to [clause 3D.10](#) for the detailed requirements.

Siting of development

[Clause 3D.11 \(2\)](#)

On large lots (greater than 4ha), development standards are established that locate buildings away from and below ridgelines, so that development does not dominate prominent ridgelines.

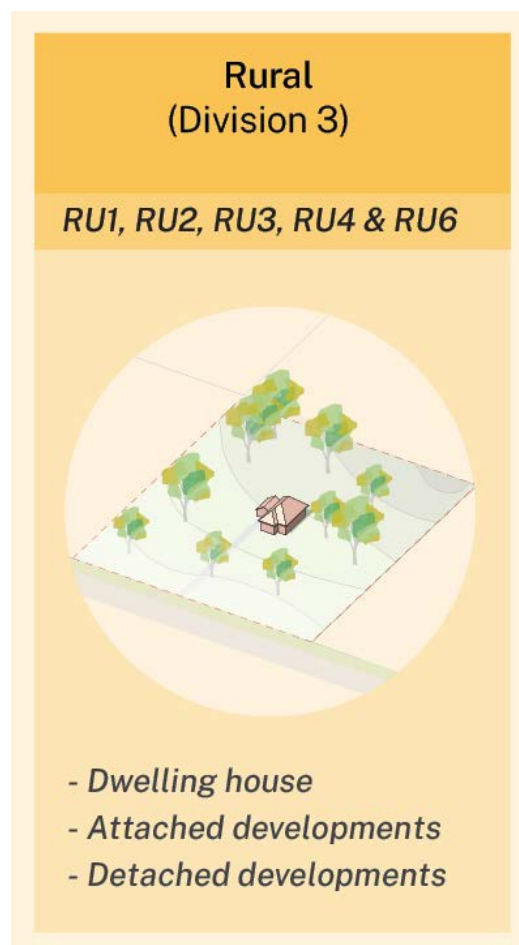
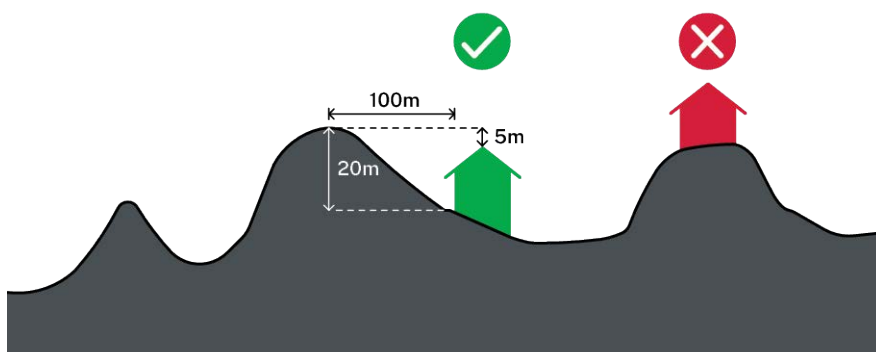

Rural lots

Development standards (based on lot size)

The development standards summary tables provide details on the key controls only in the relevant Codes SEPP. Refer to the specific clauses in the Codes SEPP for further detail and Part 4 of this Guide for explanatory guidance.

Development standard	Landholding area in hectares (ha)
	0.4 - 10
Dwelling house and attached developments	
Maximum storeys 3D.3	2
Maximum building height 3D.11 (1)	10m
Siting 3D.11 (2)	Siting controls apply to buildings to be constructed on certain sloping land, which may influence the location and height of the building.
Sealed primary road setback 3D.12 (1)	RU1, RU2, RU3 and RU6 = 50m RU4 = 30m
Sealed secondary road setback	10m
Unsealed primary or secondary road	50m
Classified road setback 3D.12 (3)	The greater of the development standard or noted in the planning instrument or development control plan
Side setbacks 3D.12 (4)	10m
Rear setbacks 3D.12 (5)	15m
Public reserve setback 3D.12 (6)	3m
Watercourse setback 3D.12 (7)	40m
Certain adjoining land* setback 3D.13	250m for certain adjoining land: *forestry, intensive livestock agriculture, intensive plant agriculture, mines and extractive industries, railway lines, rural industries.
Driveway and crossovers 3D.15	Off-street parking must have driveway to a public road. Construction to comply with requirements of clause 3D.15 (2).

Rural lots

Development standard	Landholding area in hectares (ha)
	0.4 - 10
Maximum floor level of attached outdoor entertaining* 3D.16	4m for *balcony, deck, patio, terrace or verandah within 20m of a boundary
Detached developments (excluding studios)	
Maximum building height 3D.41	4.8m
Floor area 3D.43	100m ²
Primary and secondary road setbacks 3D.44 (1)	Behind building line or 50m if dwelling house setback more than 50m from a primary or secondary road.
Side setbacks 3D.44 (2)	2.5m
Parallel road setback 3D.44 (9)	3m
Secondary road setbacks (garage or carport) 3D.46 (6)	10m
Rear setbacks 3D.46 (7)	5m
Detached development (studios)	
Building height 3D.48 (2)	4.8m* *6m if the studio is within 0.9m of a lane
Floor area 3D.48 (3)	36m ²
Side and rear setbacks 3D.48 (5)	5m

Additional standards	
Setback exceptions 3D.14	Setbacks do not apply to certain building elements listed in clause 3D.14 such as downpipes, driveways, and paving.
Outdoor entertainment areas - 3D.16	Development standards apply to outdoor living areas to minimise potential impacts on neighbouring properties. Standards applies to attached balconies, decks, patios, pergolas, terraces and verandahs.
Car parking and access 3D.15	A lot that has off-street parking must have a driveway to a public road which is constructed to AS 2890.1
Detached developments 3D.40-49	Additional development standards apply for detached developments that vary to those for other detached developments.

Farm buildings

Application

[Clause 3D.54](#)

Works under this section of the code applies to development of a farm building (other than a stock holding yard, grain silo or grain bunker) that is not used for habitable purposes.

Development standards for division 7 apply only to land zoned RU1, RU2, RU3, RU4, RU6 and R5.

Applies to landholdings with a minimum size of 4,000m²

Refer to [clause 3D.54](#) for the detailed requirements.

Land holding area

Landholdings include one or more lots of land (whether held under the same title or different titles) that constitute or are worked as a single property.

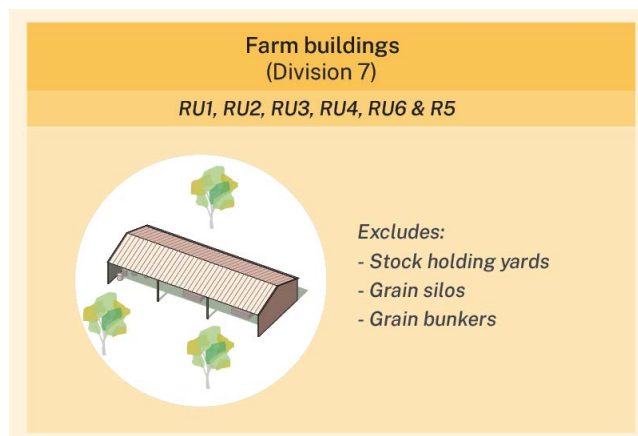
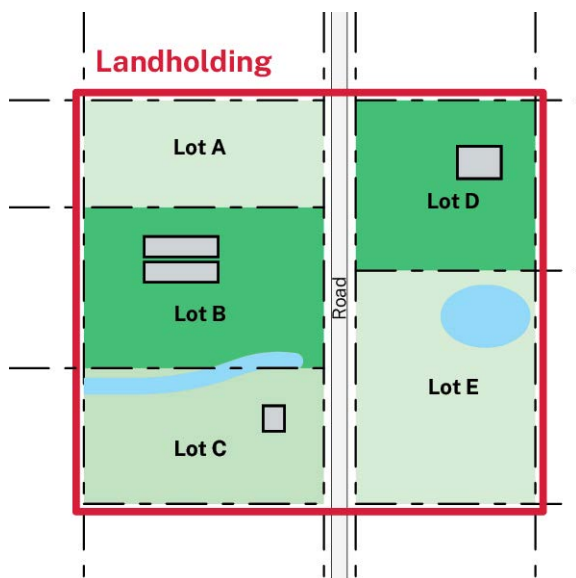

Siting of development

[Clause 3D.56 \(2\)](#)

On large lots (greater than 4ha), development standards are established that locate buildings away from and below ridgelines, so that development does not dominate prominent ridgelines.

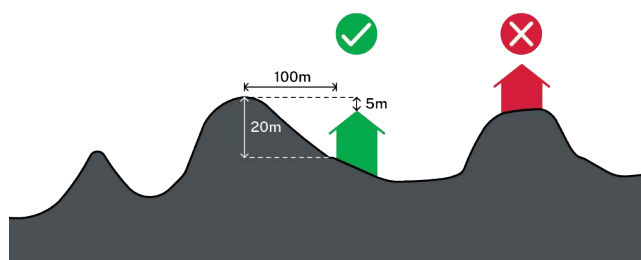

Additional development standards [Clause 3D.60](#)

Additional standards apply to shipping containers and or scenic protection land. Refer to clause 3D.60 for the detailed requirements.

Farm buildings

Development standards (based on landholding size)

The development standards summary tables provide details on the key controls only in the relevant Codes SEPP. Refer to the specific clauses in the Codes SEPP for further detail and Part 4 of this Guide for explanatory guidance.

Development standard	Landholding area in hectares (ha)					
	0.4-4	4 - 10	>10-40	>40-100	>100-400	>400
Maximum building height 3D.56 (1)	7m		10m			
Siting 3D.56 (2)	Siting controls apply to farm buildings to be constructed on certain sloping land, which may influence the location and height of these farm buildings					
Maximum footprint (per farm building) 3D.57 (1)	200m ²		500m ²	1200m ²		
Maximum footprint of ancillary office 3D.57 (2)	50m ²					
Maximum footprint of all farm buildings (excl. Grain bunkers) 3D.58	2.5% of area of landholding to a maximum of 1,000m ²		2000m ²			
Minimum classified road setback 3D.59 (2)	20m	50m				
	or, as specified in an EPI or DCP (whichever is greater)					
Minimum setback from water body (natural) 3D.59 (5)	50m					
Maximum no. Shipping containers 3D.60 (1)	1				5	

Development standards (based on building footprint)

Development standard	Zone	Building footprint		
		0-100	>100-500	500-1,200
Primary, secondary and parallel road setback 3D.59 (1) and (4)	R5	15m		200m
	RU4	30m		200m
	RU1, RU2, RU3 and RU6	50m		200m
Side and rear setbacks 3D.59 (3) and (4)		10m	50m	200m

Part 4 Housing Alteration Code

Summary of key development standards

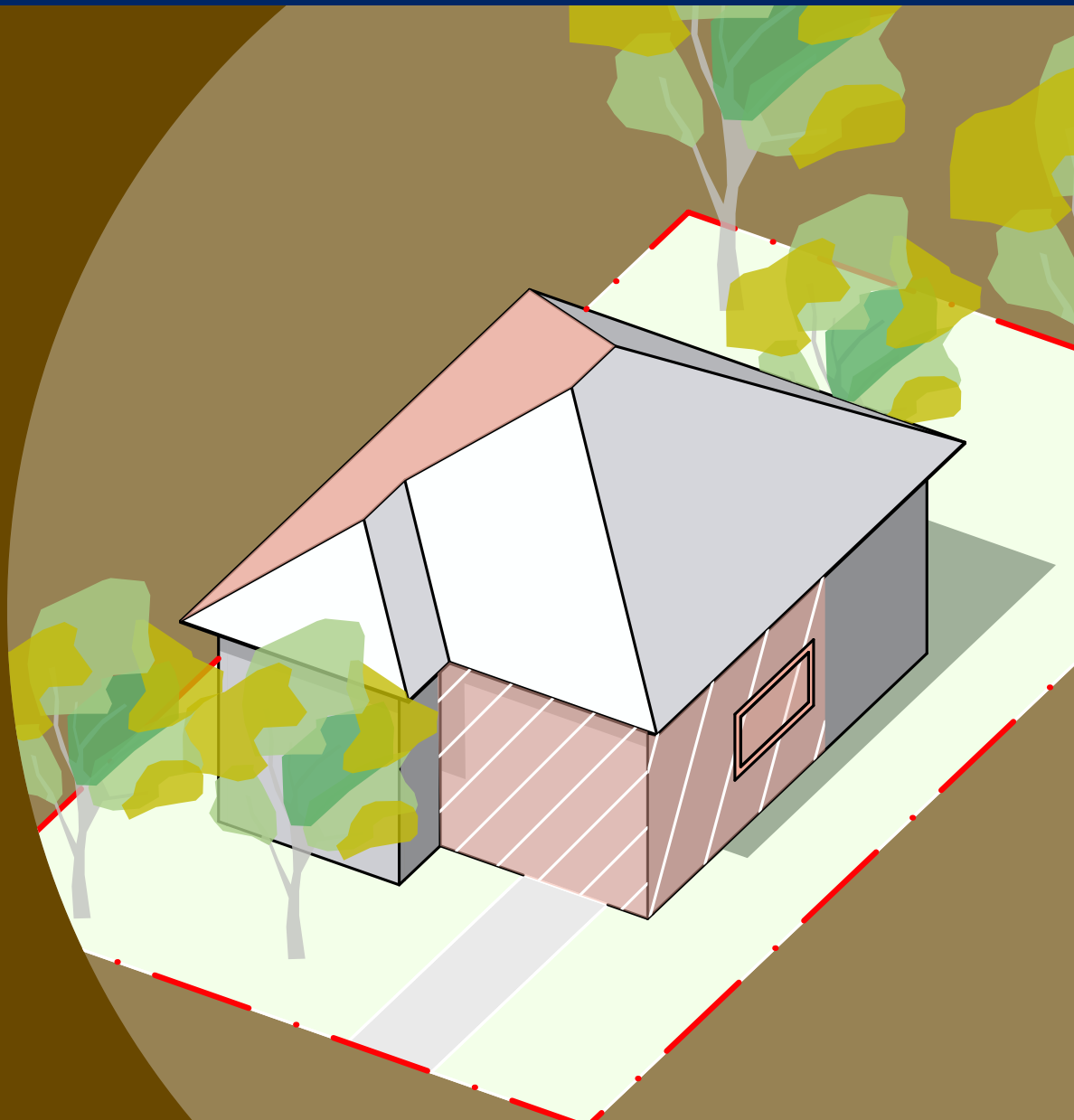

What is complying development under this code?

Part 4

For works to be complying development under Part 4 Housing Alterations of the Code SEPP the proposed works must be for:

- Internal alterations
- Minor external alterations to houses, and ancillary buildings
- Minor external alterations to buildings within heritage conservation areas
- Attic conversions

Bushfire prone land

Alterations under this Code may be undertaken on land that is partially or wholly within bushfire prone land, provided it specifications and requirements of Planning for Bush Fire Protection.

Internal alterations

Clause 4.1

Internal alterations to existing residential buildings.

A range of minor interior alterations are also possible under the Part 2 Exempt Development Code. Check to see if your works are exempt before pursuing complying development.

Development standards

Internal alterations to existing residential buildings are permissible under this code, provide they comply with the following:

- Must not result in a change of building classification under the Act or the BCA

- **Must** not result in any additional dwelling
- **Must** not result in an additional **floor (storey) in a dwelling**
- **Must** not result in a change to the number of bedroom in the building.

NOTE: Does not apply to Class 1a buildings.

Building classes

The BCA organises different building uses by a series for classifications.

The building classifications relevant to this Guide are:

Class 1a - detached houses, or groups of houses separated by a vertical wall (such as a town house, or terrace)

Class 2 - a building containing multiple dwellings (such as a manor house, dual occupancy above and below, or an apartment building)

Class 10 - non-habitable buildings such as carports, garages, sheds, fences, and swimming pools

External alterations to existing dwellings and ancillary buildings *Clause 4.3*

Development standards

External alterations to existing residential buildings are permissible under this code, provide they comply with the following:

- Must not result in a change of building classification under the Act or the BCA
- Must not change the:
 - floor area
 - building footprint
- Must not increase the existing height
- Must not change the roof pitch by more than 5%
- Must not enclose any carport
- A new window must have a privacy screen as per the table

Habitable window side or rear setback	Room height above ground level	Privacy screen required
<3m	<1m	No
<3m	>1m	Yes*
3-6m	<3m	No
3-6m	>3m	Yes*

*Not required for bedroom windows of less than 2m²

Heritage areas (including draft HCAs)

Two special conditions apply to heritage conservation areas (HCAs):

- External alterations may be to the ground floor only
- Changes to windows must not be on a wall facing the primary road, or on a wall connected to a wall facing the primary road

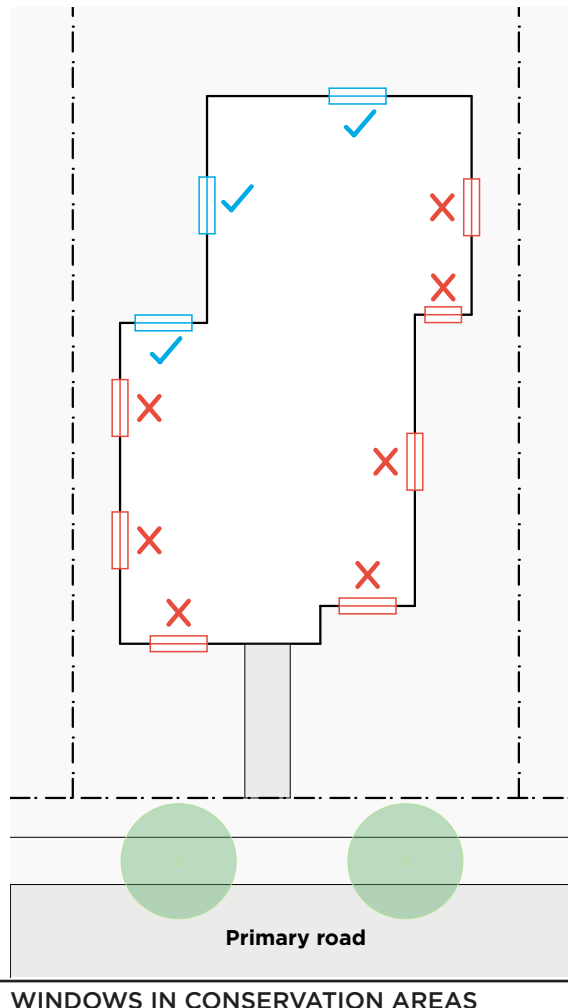
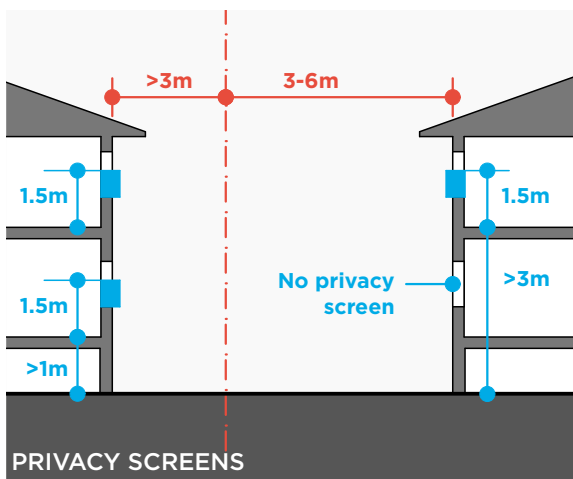
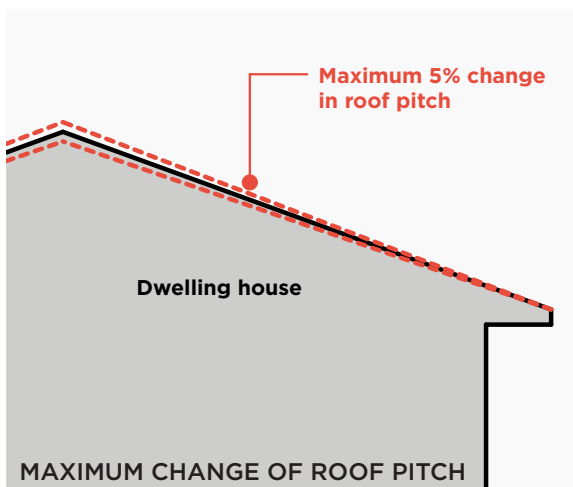

External alterations to other residential buildings

Clause 4.4A

External alterations to existing residential buildings other than dwelling houses (for example, dual occupancies and terraces) are permissible under this code, provided they:

- are not within a HCA or draft HCA, and
- are not on a flood control lot, and
- are not for a new balcony, deck, patio, terrace or verandah
- comply with development standards

Development standards

- Must not result in a change of building classification under the Act or the BCA
- Must not increase the gross floor area
- Must only use materials and colours similar to the existing building
- Must not affect any existing fire resisting components of the building
- Must not affect the means of egress from the building in an emergency
- Must comply with LEP height limits, and if none specified, must not be higher than the uppermost habitable floor
- Must be at least 3m from a side or rear boundary
- *Must be located behind the building line of any primary or secondary road frontage
- **External work to an existing building may only be carried out on the first
- 3 levels (not including basement or parking levels) of the building
- Alterations to an existing balcony, deck, patio, terrace or verandah must not increase the floor area or floor level above existing

*Excluding pedestrian ramps or stair lifts) **

**Excluding is the works are for installing or altering existing services and utilities

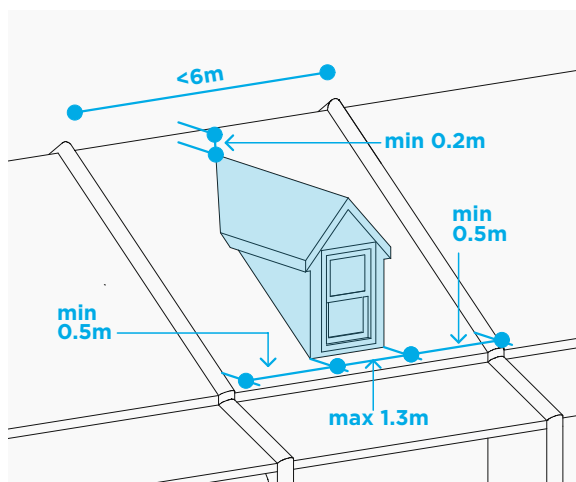

Attic conversions

Clause 4.5

Attic conversions to existing houses completed [before 2nd February 2011](#) are permissible provided they meet the development standards.

Note: An attic is not included in the definition of a storey.

Development standards An attic must:

- be entirely within the roof space
- not change the roof pitch
- have 1 or 2 dormer windows:

Building width	Number of dormer windows
Less than 6m	1
More than 6m	2

Dormer windows must:

- not exceed a width of more than 1.3m
- be at least 200mm below the existing roof ridge height
- must be set in at least 500mm from the edge of the roof
- if facing the rear yard, must not have an area more than 4m²

Heritage Conservation Areas

Attic conversions in an HCA or draft HCA must:

- not have a dormer or extend the roof
- only have windows that are flush and located on the existing rear roof plane no greater than 1.5m² in total area

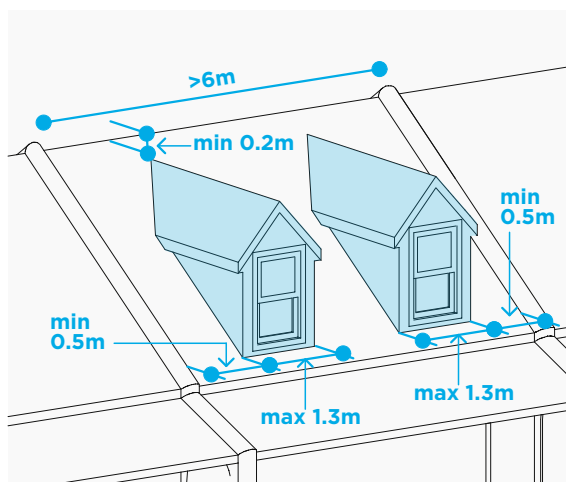

Step 4

Explanatory guidance

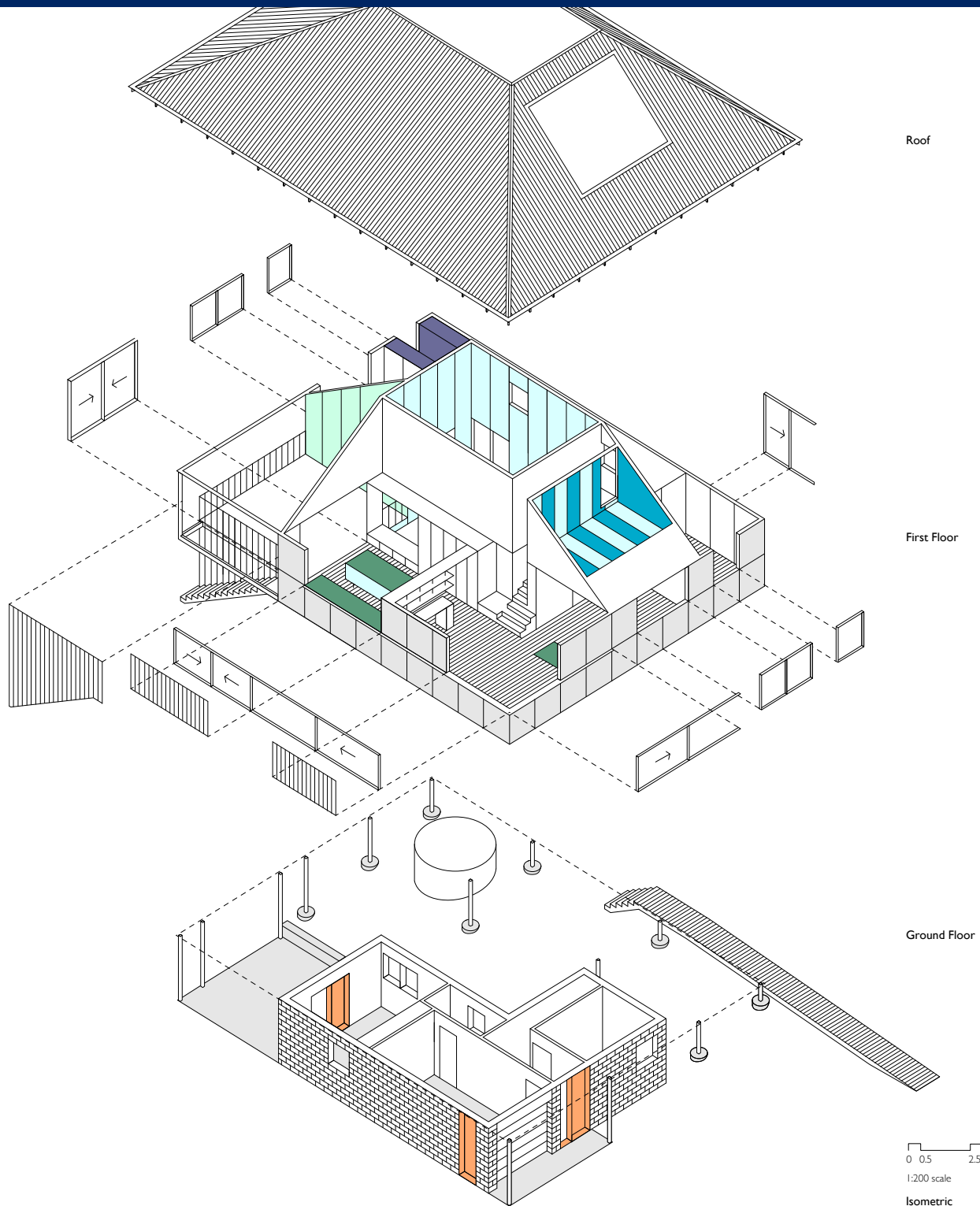

Contents

Step 4	4-01	External elements	4-17
How to read Step 4	4-2	Balconies, decks, patios, terraces and verandahs	4-17
Development types	4-3	Landscaped area	4-18
Dwelling house	4-3	Private open space	4-18
Attached development	4-3	Trees	4-19
Detached development	4-3	Swimming pools	4-20
Detached studios	4-3	Fences	4-21
Lot types	4-4	Amenity	4-22
Typical lot types	4-4	Windows, doors and openings	4-22
Defining corner lots	4-5	Heights of building elements	4-22
		Articulation-new dwelling houses	4-23
Land specific requirements	4-6	Privacyscreens	4-24
Bushfire prone land	4-6	Car parking and access	4-25
Flood Control Lots	4-7		
Key measurements	4-8	Earthworks, retaining walls and drainage	4-26
Lotwidth.	4-8	Excavation	4-26
Gross floor area	4-9	Fill	4-26
Lot/landsize	4-9	Retaining walls	4-27
		Drainage	4-27
Building envelope	4-10		
Storeys	4-10		
Setbacks	4-11		
Setbacks-irregular block types	4-12		
Primary road setbacks	4-13		
Secondary road setbacks	4-14		
Side setbacks	4-14		
Building to side boundaries	4-15		

How to apply the Codes

How to read Step 4

Step 4 includes explanatory guidance for many of the common and key controls within the Codes SEPP.

It provides illustrations to assist in interpreting the controls and definitions used within the Codes SEPP and individual housing codes.

Note:

Multi-dwelling projects being undertaken under Part 3B Low Rise Housing Diversity Code should refer the Low Rise Housing Diversity Design Guide for guidance on applying the development standards.

Given the different type of building, farm buildings being undertaken under Part 3D Rural Housing Code, should refer to the Codes SEPP for detailed controls.

Development types

Dwelling house

Dwelling house means a building containing only one dwelling, an attached dwelling, or semi-detached dwelling, but does not include any part of the building that is ancillary development or exempt development under the Codes SEPP.

Attached development

A attached development is any development that is located less than 0.9m away from the dwelling.

Examples include:

- access ramp
- awning blind or canopy
- balcony, deck, patio, pergola, terrace or verandah
- basement
- cabana, cubby house, fernery, garden shed, or greenhouse
- carport
- driveway
- garage or hardstand space
- pathway or paving
- rainwater tank
- retaining wall
- shed

Detached development

A detached development is any development that is located at least 0.9m away from the dwelling.

Examples include:

- studio
- cabana, cubby house, garden shed
- deck, patio, pergola, terraces, verandah
- carport, garage
- shade structure
- pathway or paving
- does not include a secondary dwelling house

Additional development standards apply for detached developments which are noted throughout the relevant sections in this Guide.

Detached developments may not be erected on a lot in a heritage conservation area or draft heritage conservation area if the lot adjoins a lane, secondary road or parallel road.

Detached developments may only be erected in heritage conservation areas if the lot does not adjoin a lane, secondary road or parallel road and the detached development is:

- behind the rear of the building, and
- is not a detached studio
- is not closer to the side boundaries than the dwelling house, and
- has a floor area of no more than 20m²

Detached studios

A detached studio adjoining a laneway is a common development type found on smaller lots. The building is separate from the dwelling house and often contains a garage. The detached studio is a habitable room but is not a separate dwelling.

These works cannot be undertaken in a draft heritage conservation area or heritage conservation area.

A maximum of one detached studio is permitted on a lot.

Additional development standards specific to detached studios are noted throughout the relevant sections of this Guide.

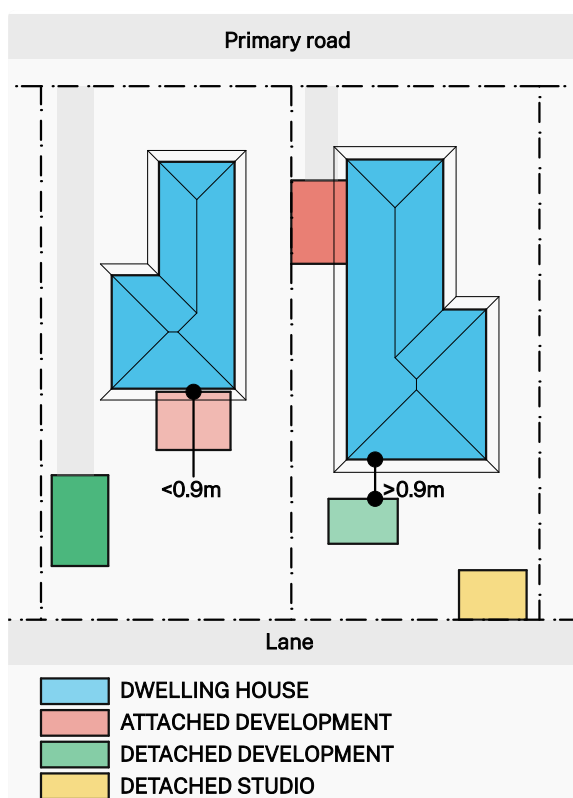

Lot types

Typical lot types

In the code, lots are dividing into the following categories:

Standard lot

A standard lot is defined by a lot that is not a battle-axe, corner or parallel road lot.

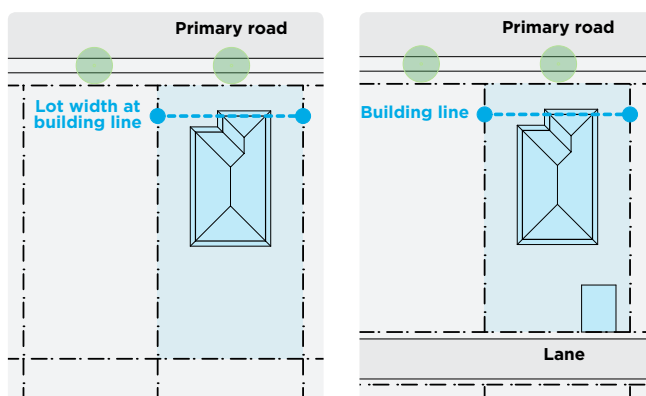

Parallel road lot

Parallel road lot is a lot that has boundaries with two parallel roads, not including a lane.

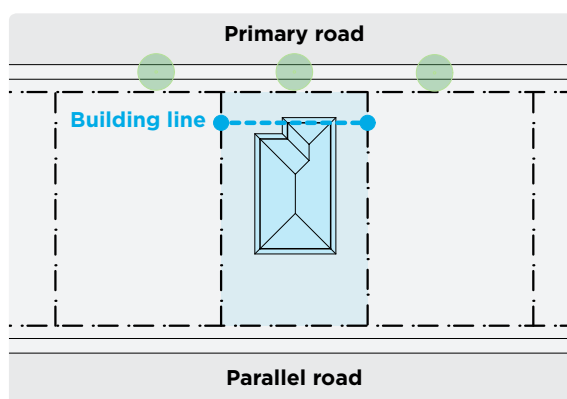

Corner lot

A corner lot is a lot that has 2 contiguous boundaries with a road or roads (other than a lane) that intersect at an angle of 135 degrees or less (whether or not the lot has any other boundaries with a road).

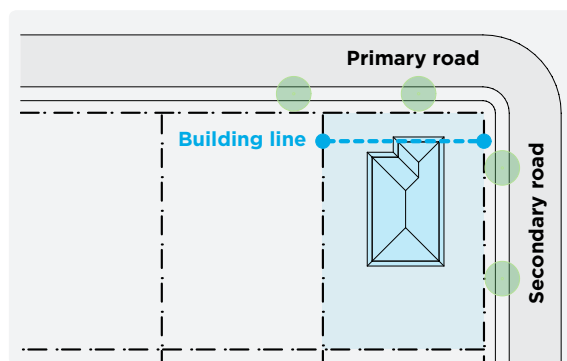

Battle-axe lot

A battle-axe is a lot that has access to a road by an access laneway.

A battle-axe lot has 3 side boundaries and a rear boundary. The rear boundary is opposite the boundary to which the front of the dwelling house faces.

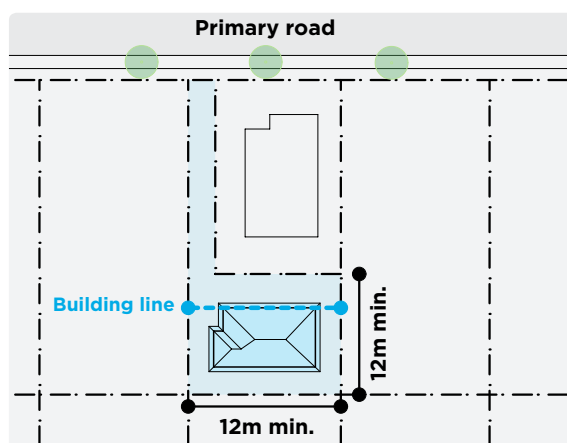

Defining corner lots

Determining a lot type is not always straightforward, particularly when your land shape is irregular or does not resemble the examples earlier. See below for a range of lot types of varying characters.

A corner lot is defined by:

- A corner lot has a primary and secondary road frontage.
- The angle where the primary and secondary road boundaries meet must be less than 135 degrees to be a corner lot.
- If the angle is greater than 135 degrees, it is a standard lot.

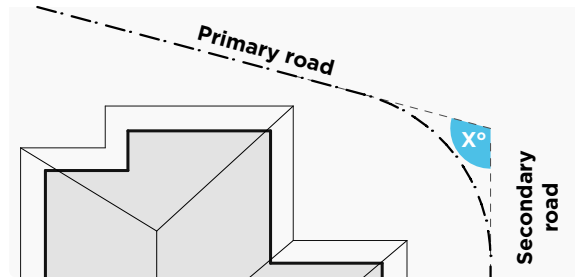
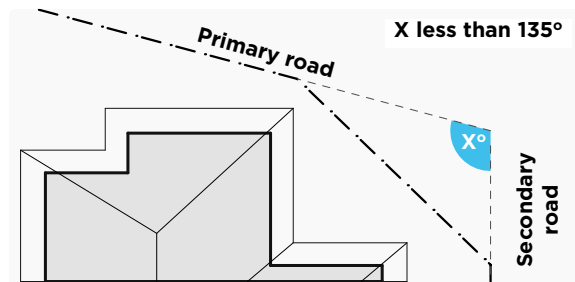

Splayed and curved corner lots

A lot with a splayed or curved corner, and an angle where the primary and secondary streets intersect of less than 135°, it is a corner lot.

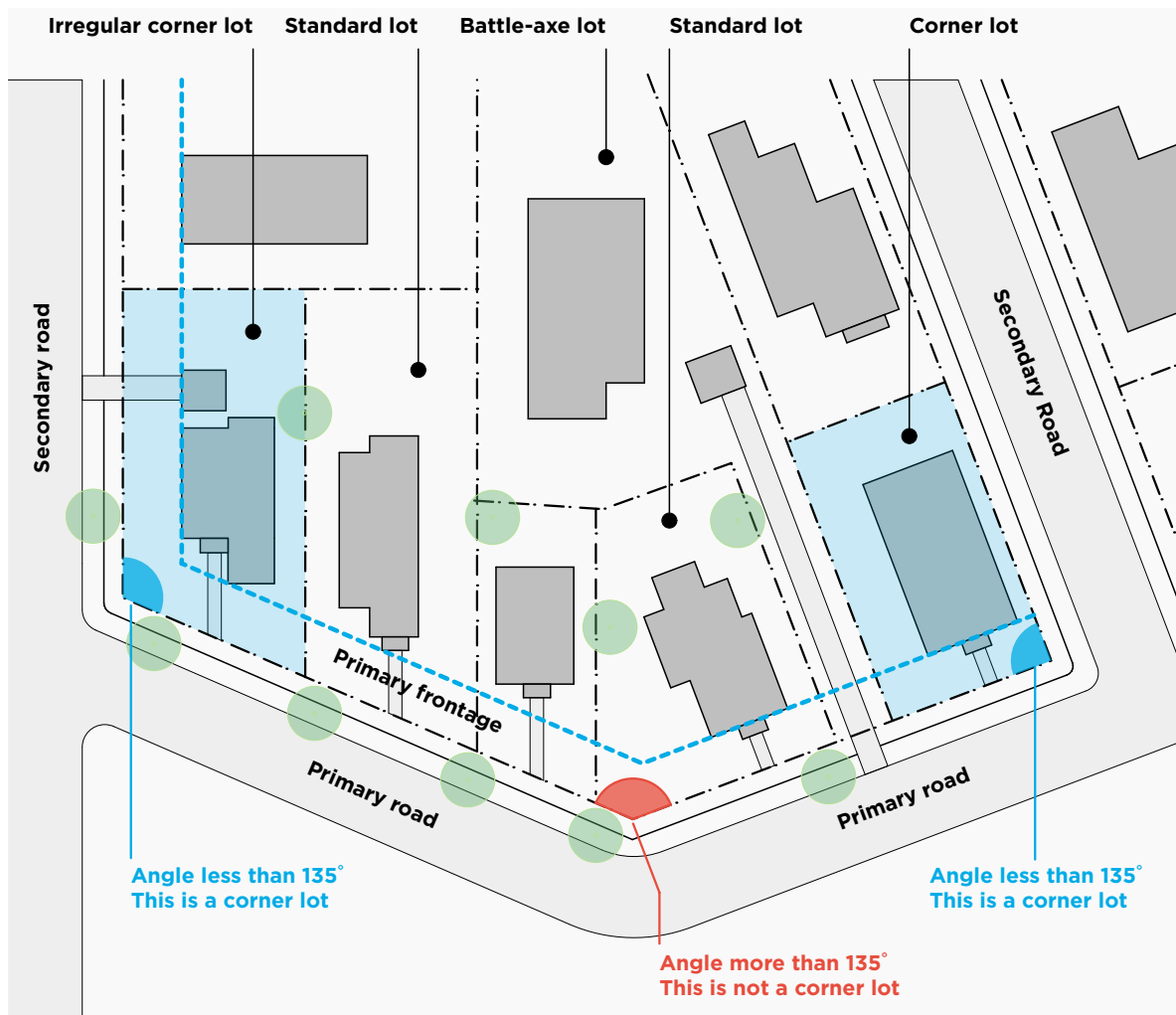

Land specific requirements

Bushfire prone land

For land that is bushfire prone, but permissible under clause 1.19A of the Codes SEPP (and as detailed in Step 2.4 of this Guide), additional development controls are required.

Refer to the relevant code for exclusions and detailed requirements:

- Part 3 Housing Code [clause 3.4](#)
- Part 3A Rural Housing [clause 3A.37](#)
- Part 3B LRHD [clause 3B.4](#)
- Part 3C Greenfield Housing [clause 3C.5](#)
- Part 3D Rural Housing Code [clause 3D.6](#)

The development must conform to the specifications and requirements of Planning for Bush Fire Protection that are relevant to the development

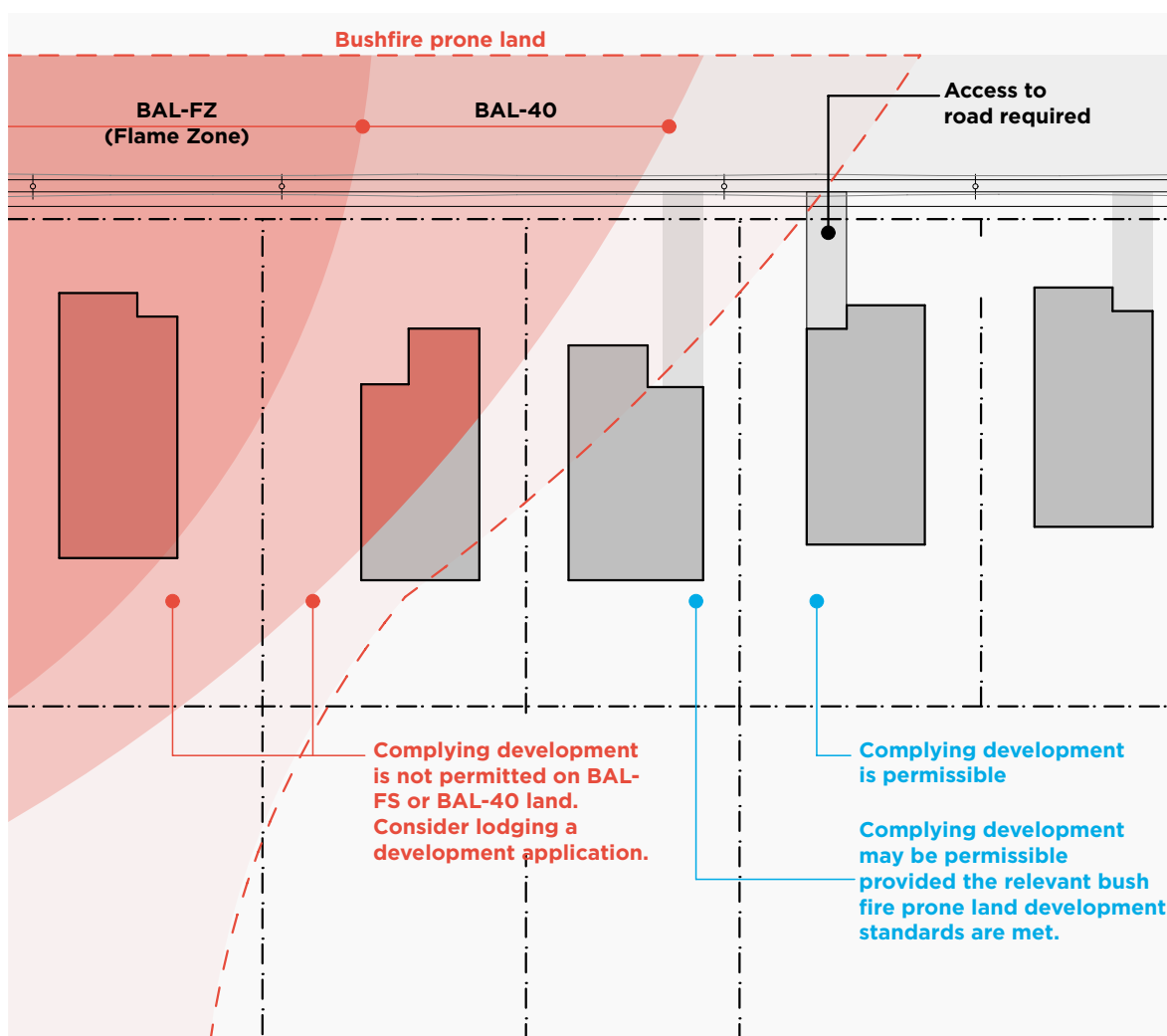

Flood control lots

For land that is flood prone, but not high hazard or high risk (and as detailed in Step 3 of this Guide), complying development may be possible provided additional criteria are met.

Refer to the relevant code for exclusions and detailed requirements:

- Part 3 Housing Code [clause 3.5](#)
- Part 3A Rural Housing [clause 3A.38](#)
- Part 3B LRHD [clause 3B.5](#)
- Part 3C Greenfield Housing [clause 3C.6](#)
- Part 3D Rural Housing Code [clause 3D.7](#)

Further input from council or a hydraulic engineer will be required on flood control lots.

A section 10.7 certificate from council will state whether or not a lot is a flood control lot.

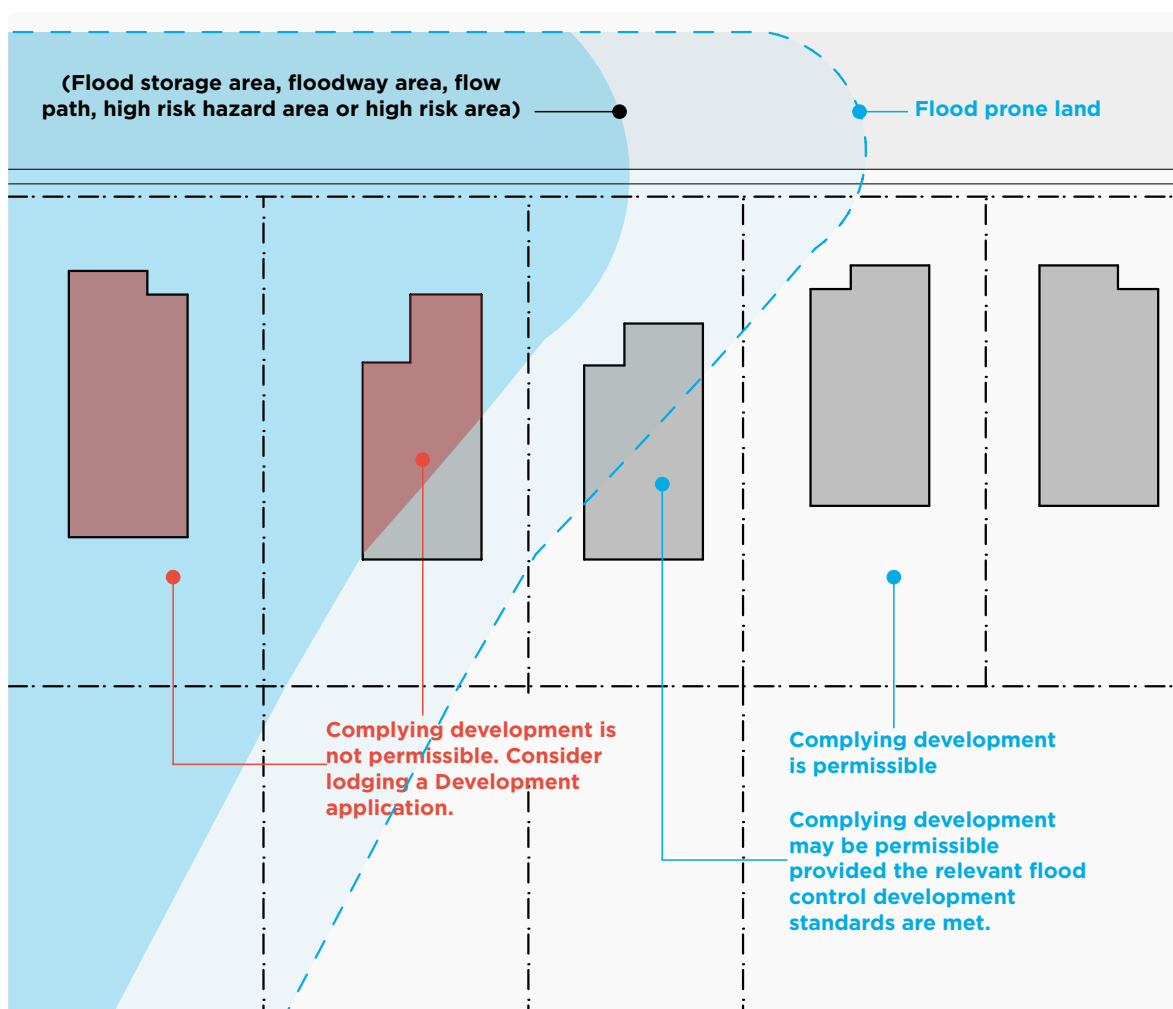

Key measurements

Lot width

Lot width as referred to in the development standards is the measurement from boundary to boundary as taken at the front most building line of the building.

The building line follows the alignment of the front most building facade.

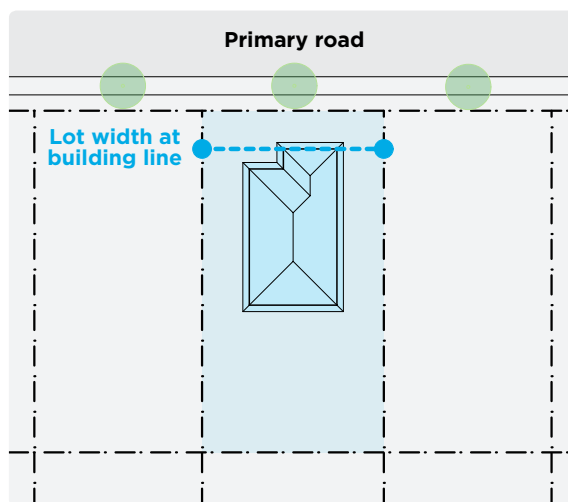

EXAMPLE 1: STANDARD LOT

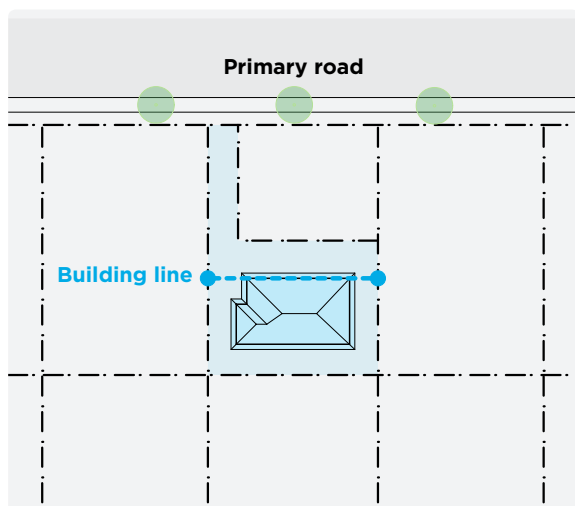

EXAMPLE 2: BATTLE AXE LOT

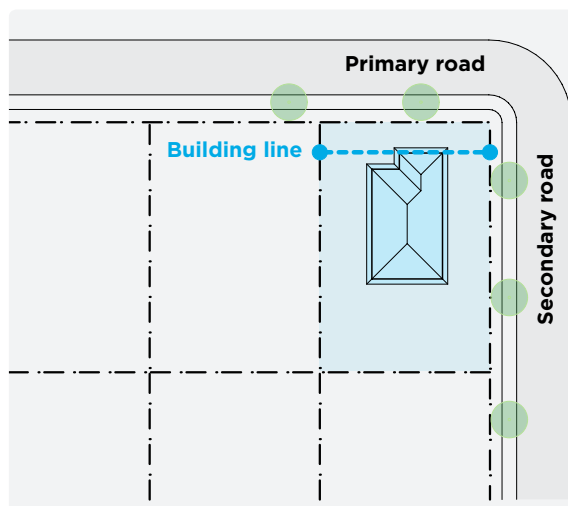

EXAMPLE 3: SPLAYED CORNER LOT

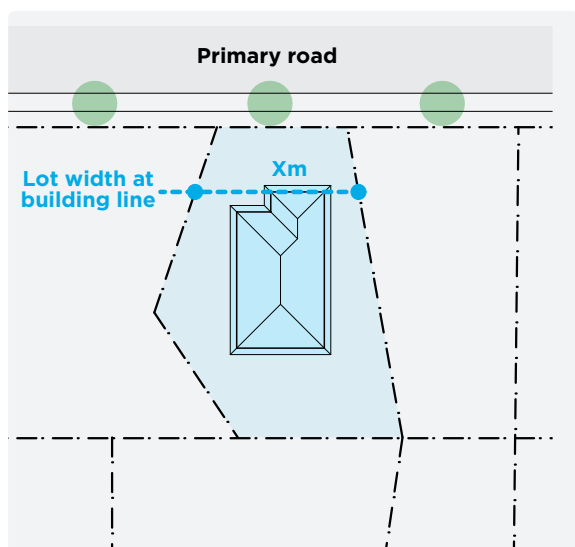

EXAMPLE 4: IRREGULAR LOT BOUNDARIES

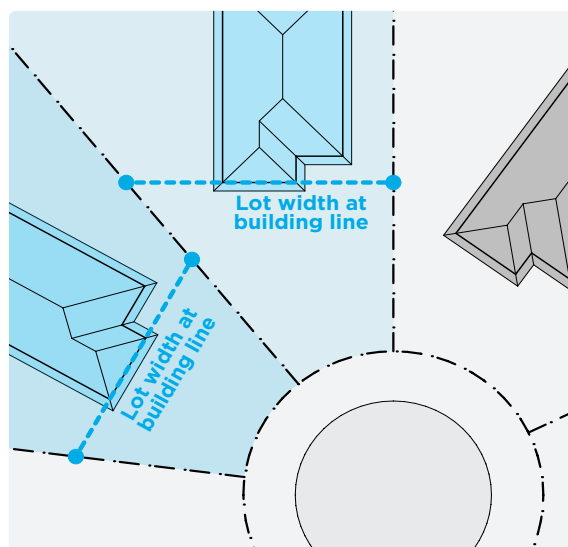

EXAMPLE 5: CUL-DE-SAC LOT

Gross floor area

Clause 1.5

Gross floor area (GFA) is measured from the internal face of the external walls of the dwelling and any attached or detached development. It includes habitable rooms in a basement or attic. The measurement is taken at a height of 1.4m and excludes:

- basement storage
- 1 car parking space including access if the area excluded is not more than 18m²
- terraces and balconies with outer walls less than 1.4m high
- voids
- common vertical circulation (e.g. the area for a stair is only counted once and not at each level)

Lot / land size

Means the area in square metres of your land. This will be noted on your survey plan.

A real estate plan may provide an approximate indication but should not be used for determining relevant development standards.

For battle-axe lots, the access laneway is to be excluded from the lot area for the purpose of calculating development standards.

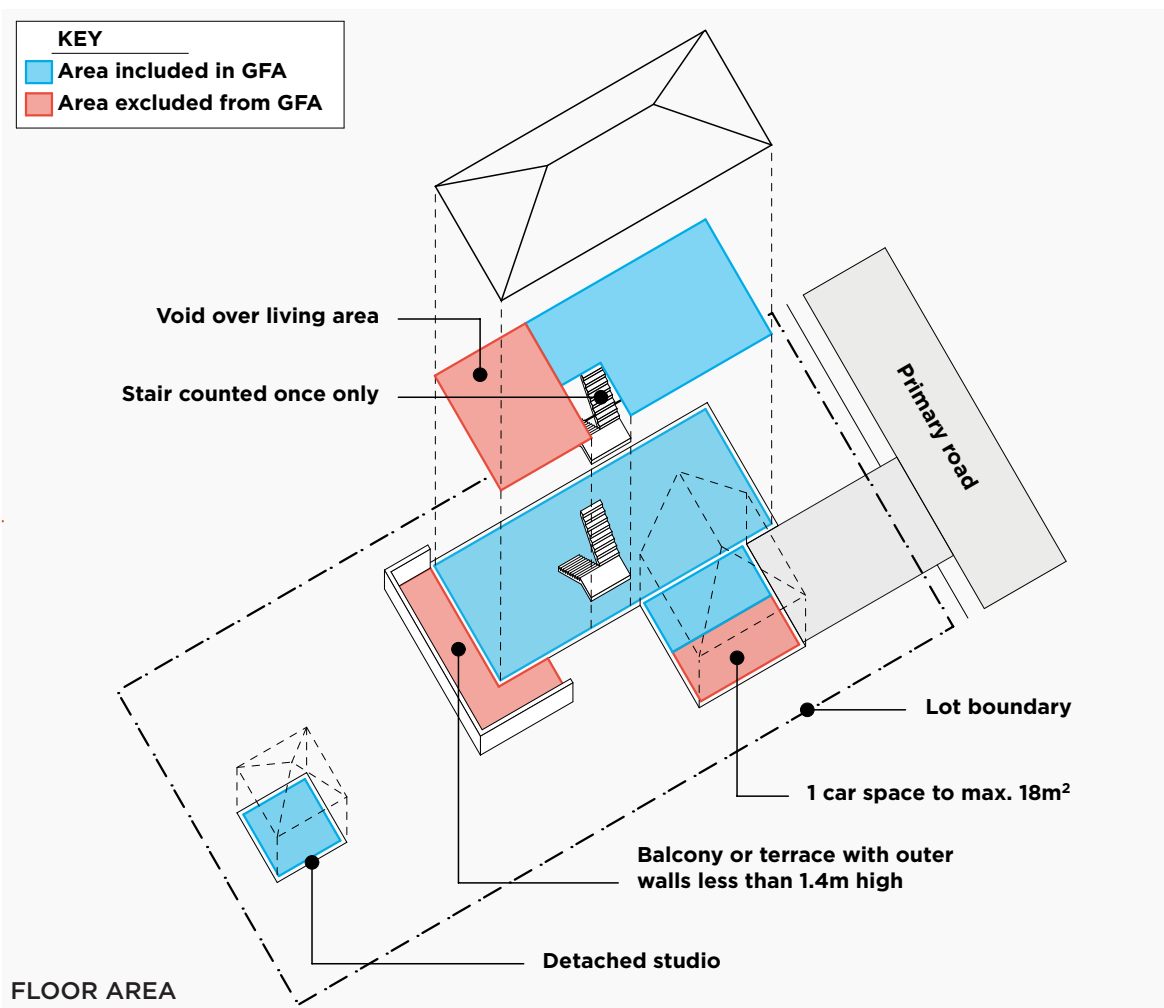

Building envelope

Height

'Building height' is the height of the building at any point of a building, and is the vertical distance between a point at ground level (existing) and the highest point of the building immediately above that point, including plant and lift overruns, but excluding communication devices, antennae, satellite dishes, masts, flagpoles, chimneys, flues and the like.

Storeys

For the purposes of calculating the number of storeys, any basement is to be counted as a storey.

Storeys are counted as the levels between one floor and the next floor level and the next, or if there is no floor above, the ceiling or roof above. This does not include:

- an attic
- a lift shaft
- a mezzanine
- a stairway

Although a basement is counted as a storey a basement is categorised as a type of an attached development when referring to the development standards of the Codes SEPP.

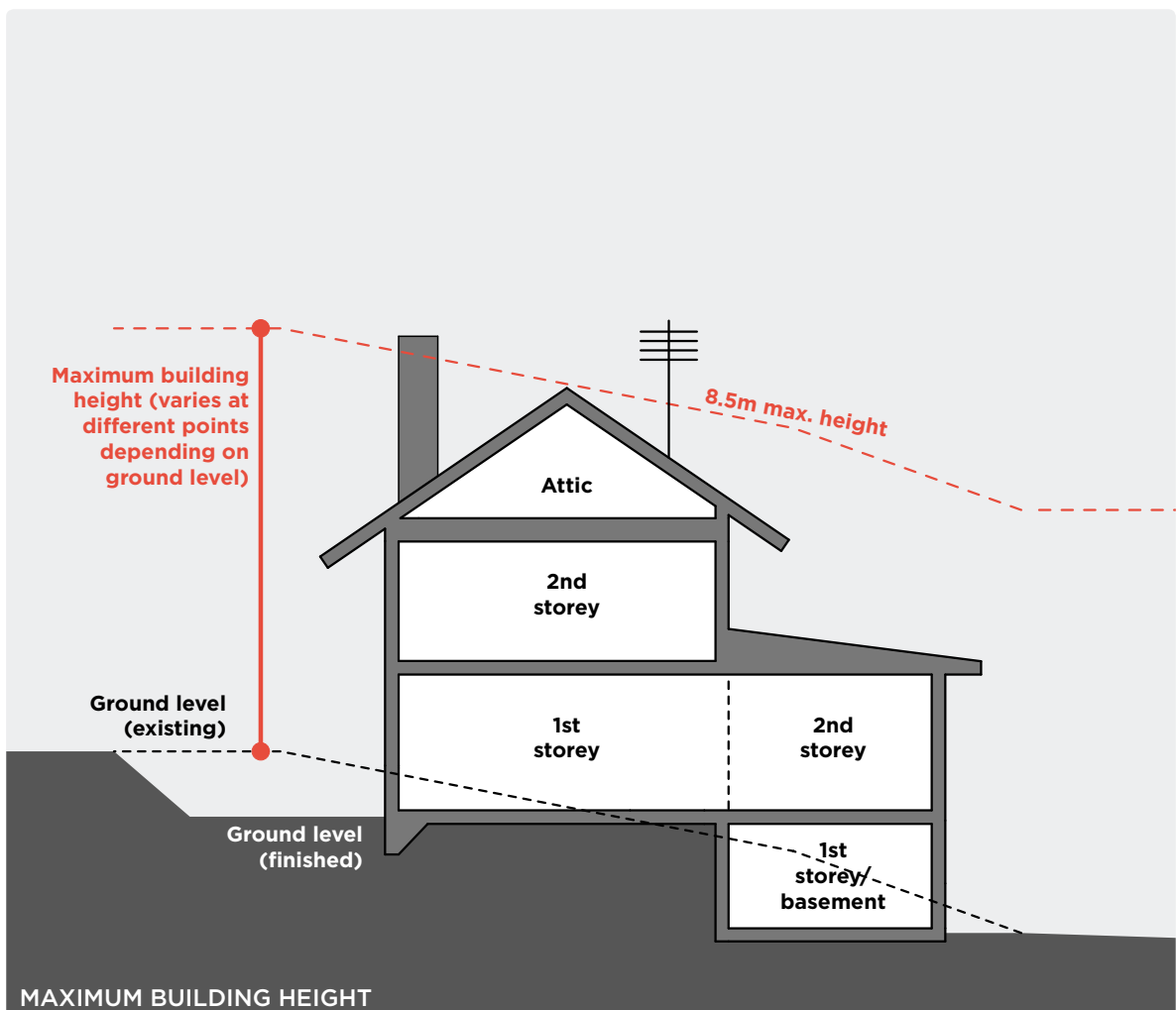

Setbacks

Setbacks determine how close development can be constructed from a particular boundary. Refer to the Development Standards for specific setback controls.

Setbacks are the horizontal distance between the relevant boundary and the building line. They are measured at 90 degrees from the boundary to:

- a building wall,
- the outside face of any balcony, deck or the like,
- the supporting posts of a carport or verandah roof, whichever is the shortest.

Allowable encroachments Encroachments within the required setbacks are permitted in certain instances for minor building elements listed in the Codes SEPP.

Encroachments within 900mm will need to comply with clause 3.7.2.7 of Volume 2 of the Building Code of Australia (BCA) of Australia. Permissible encroachments of setback controls does not grant permission to build over a boundary.

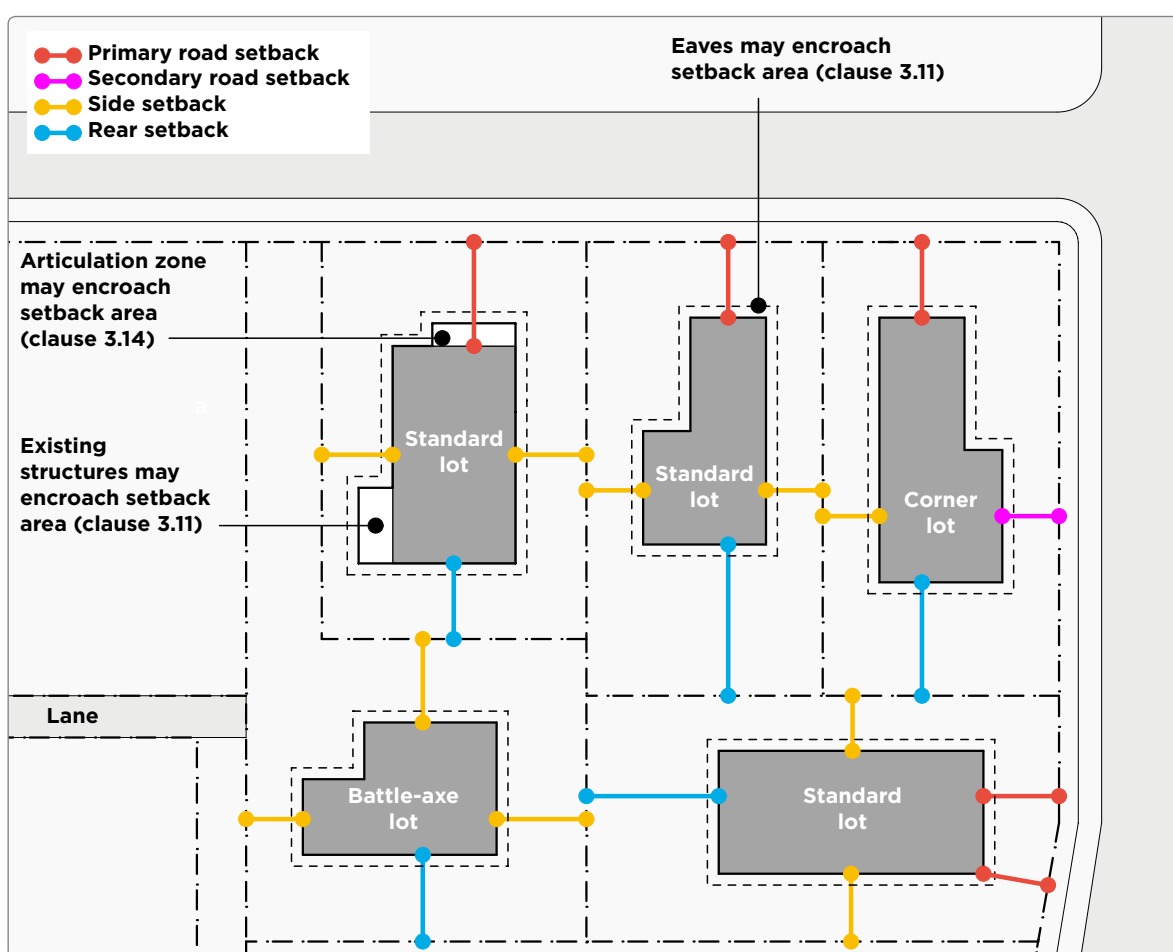

SETBACK TYPES

Setbacks - irregular block types

The geometry of lot boundaries is often irregular. The following examples illustrate common irregular lot geometries and how to determine minimum setbacks.

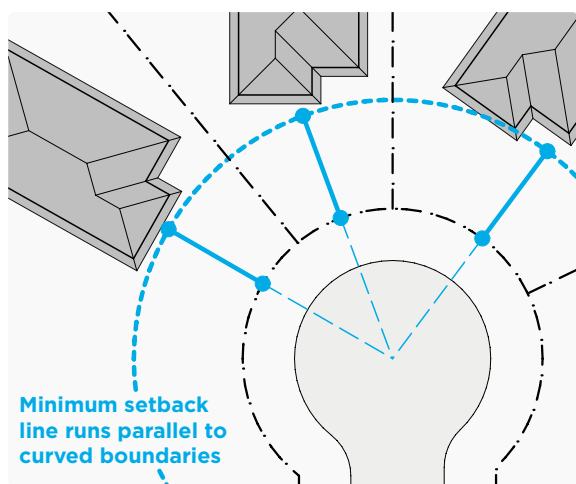

CUL DE SACS

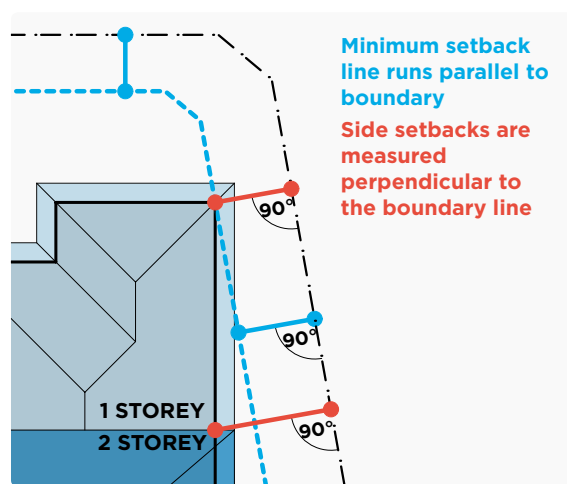

ANGLED BOUNDARIES

Curved and splayed boundaries on corner blocks

If the dimension (X) at the intersection of the primary (A) and secondary (B) setbacks is less than the secondary boundary setback, the setback follows the curve and is equal to the secondary street setback.

If it is more than the secondary street setback, the typical setbacks apply.

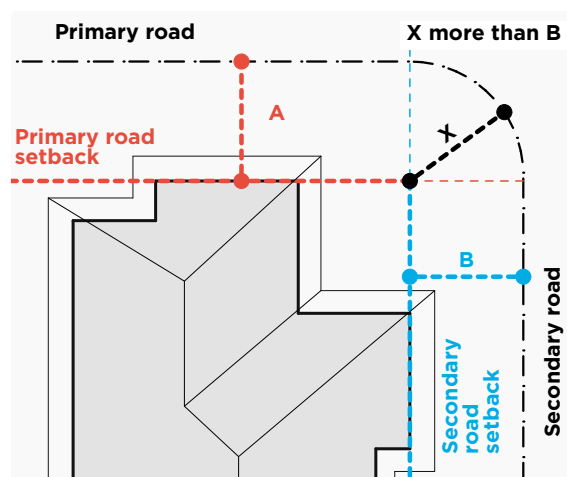
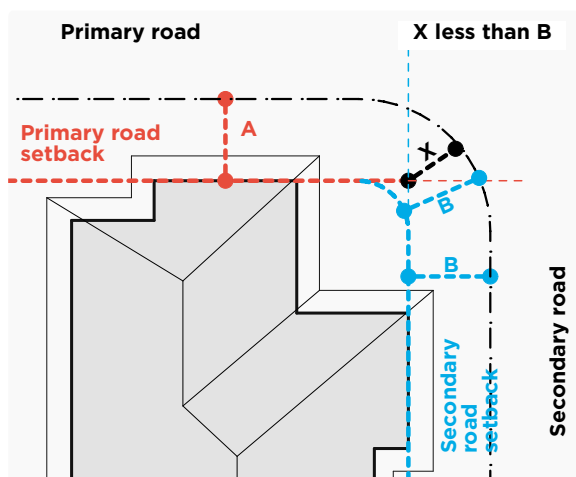
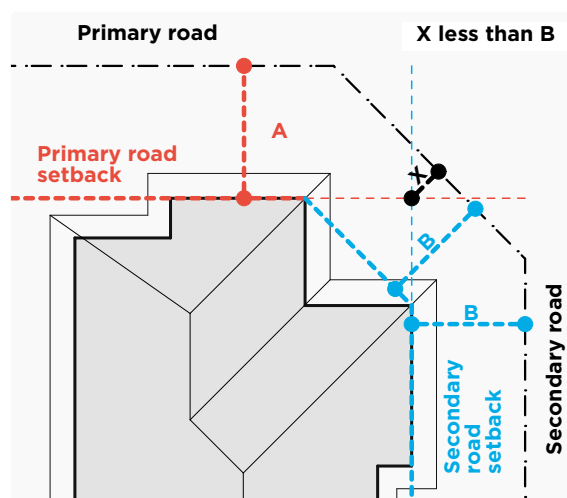

Primary road setbacks

Note: applies to:

- Part 3 Housing Code
- Part 3B LRHD

Refer to specific controls for:

- Part 3A Rural Housing [clause 3A.15](#)
- Part 3C Greenfield Housing
- Part 3D Rural Housing [clause 3D.32](#)

The primary control for front setbacks in are based on the setback of the nearest two dwelling houses.

Where there are existing neighbouring houses within 40m, the setback should be the average of those dwellings on the same primary road frontage. This excludes a dwelling house on a battle axe lot.

Where there are no neighbours (i.e. dwelling houses within 40m) a minimum setback from the primary road frontage will vary depending on the lot area in the table below.

Front setback where neighbouring houses exist within 40m	
Lot area	Front setback
All lot sizes	Average of nearest 2 dwellings*

Front setback by lot size where no neighbouring houses exist within 40m	
Lot area	Front setback
200m ² - 300m ²	3m
>300m ² - 350m ²	4.5m
>900m ² - 1,500m ²	6.5m
>1,500m ²	10m

Battle axe lot: front (side) setback	
Lot area	Front setback for front battle axe lot
Any	3m

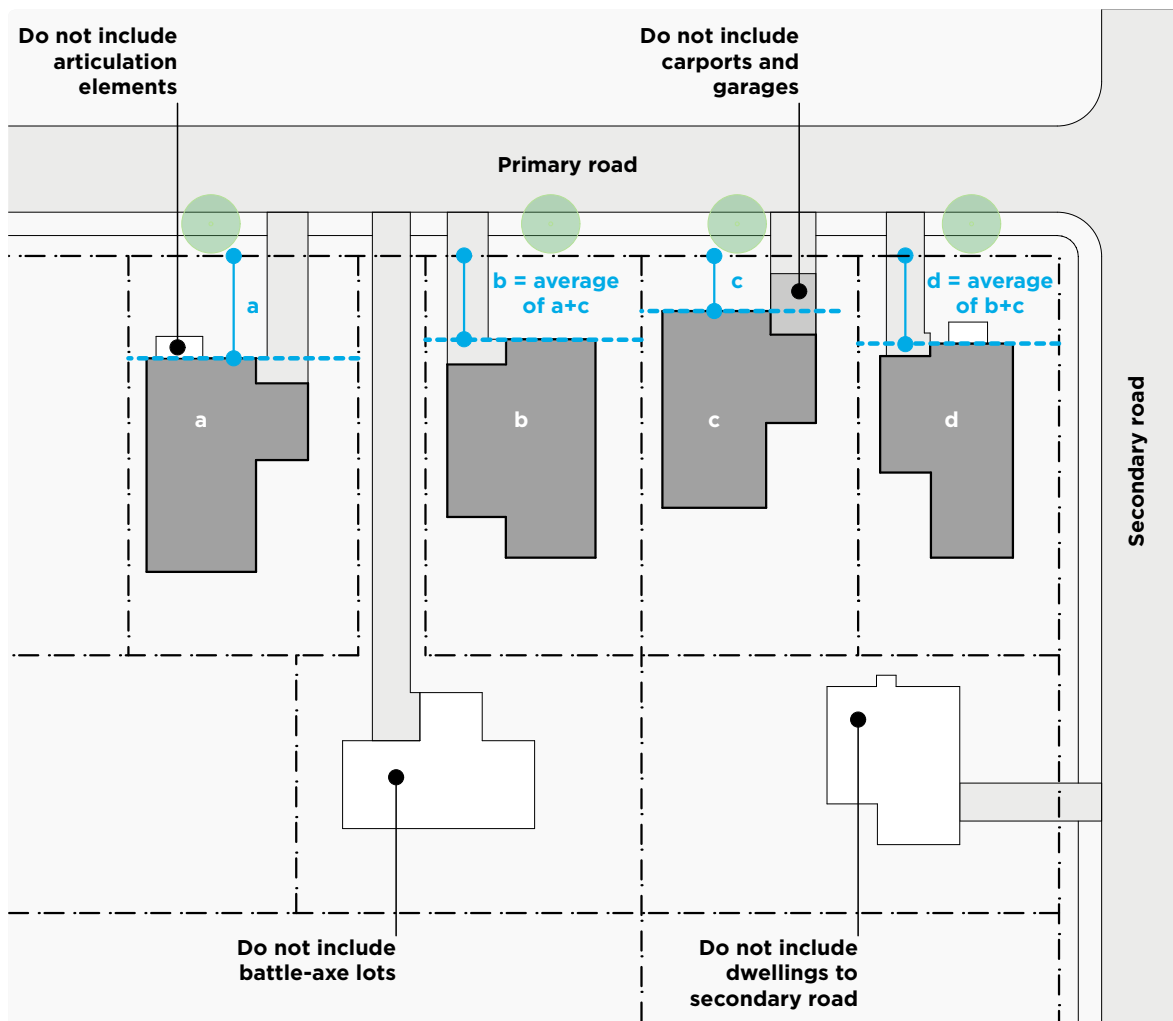

Secondary road setbacks

Dwelling houses, attached developments and detached garages or carports Minimum setbacks to secondary roads must be to the numeric control in the relevant Code.

Detached development

Detached development (other than a detached garage or carport) must be located behind the building line to the primary road and for corner lots, the secondary road.

Side setbacks

The minimum side setback varies with lot width and building height. Side setbacks increase as height increases.

Refer to the Development Standards for the specific Code to determine the numeric controls.

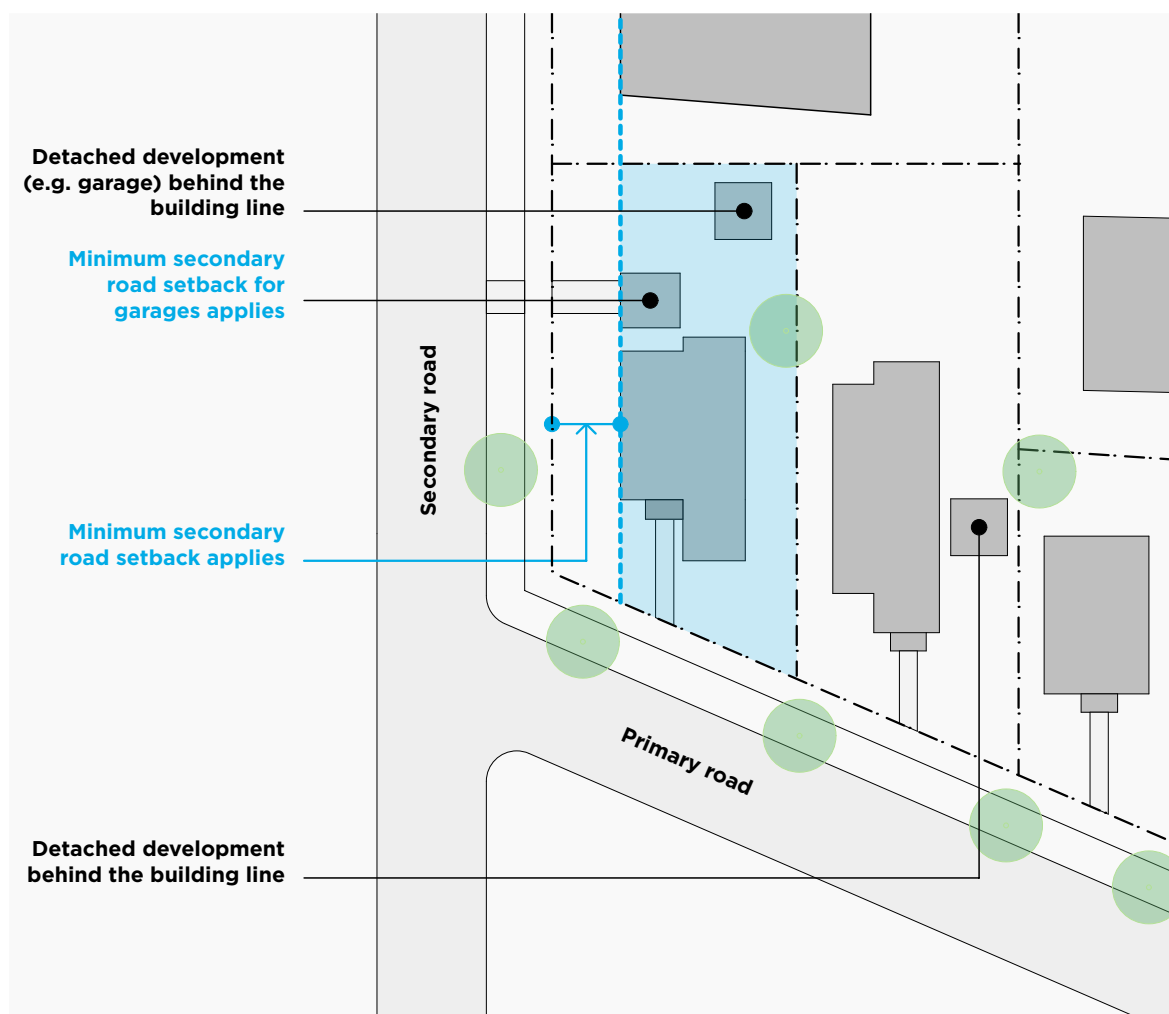
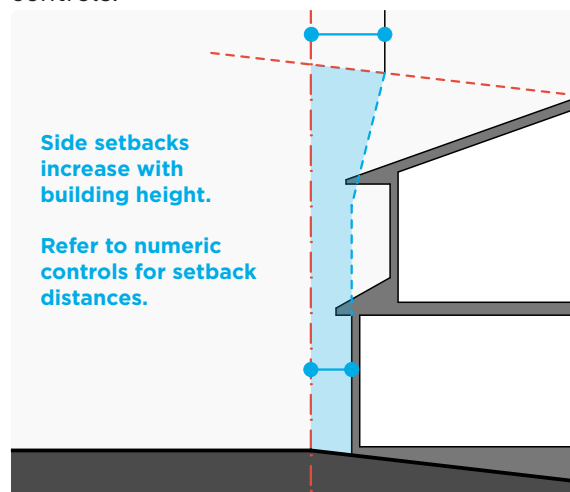

Building to side boundaries

Summary

Note: applies to Part 3 Housing Code

For non corner lots with a width of 6-12.5m, there is the option of building up to the side boundary of the lot where you comply with the standards.

Lot width at the building line	Maximum built to boundary walls
6-8m	One or both sides
8-12.5m	One side

A boundary wall cannot be built if the adjoining property has a wall within 0.9m of the boundary that:

- is not of masonry construction, or
- has a window facing the boundary.

Any wall within 0.9m of the boundary must not contain a door, window, or opening.

Maximum length of walls built to the boundary

Part 3 Housing Code:

Lot width	Maximum built to boundary wall length
6-10m	Lesser of 20m or 50% length of lot depth
10-12.5m	10m

Part 3C Greenfield Housing Code:

Lot width	Maximum built to boundary wall length
6m-7m	Lesser of 20m or 50% length of lot depth
7m-10m	Lesser of 15m or 50% length of lot depth
10m-15m	Lesser of 11m or 50% length of lot depth
15m+	No maximum

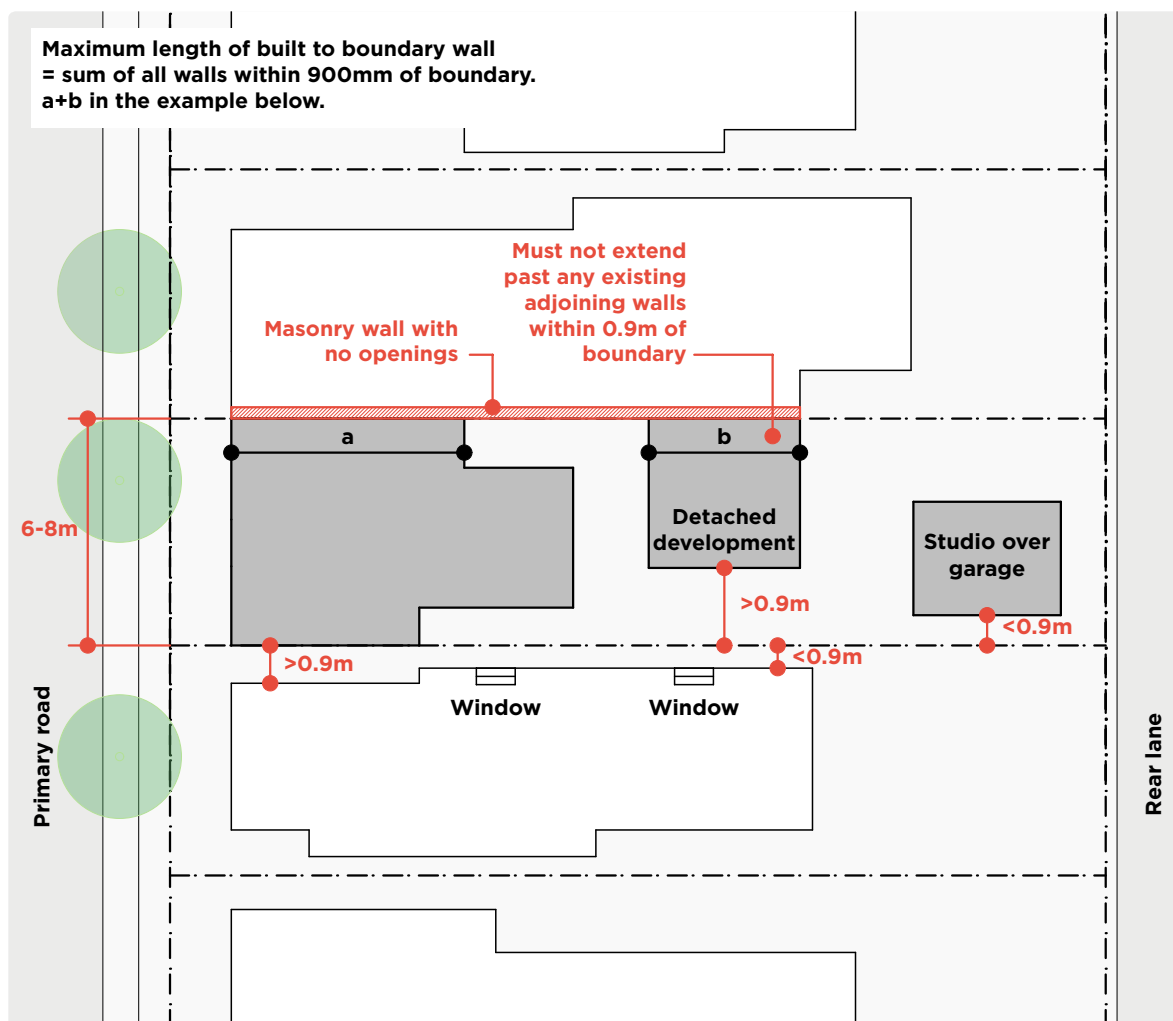

Maximum height of walls built to the boundary

Type	Max height of wall within 0.9m of boundary	Max height where adjoining lot wall within 0.9m of boundary
Dwelling house and attached developments	3.3m	8.5m
Detached development	3.3m	4.5m
Detached studio over a garage	3.3m	6m

Where it is permissible to build a wall within 900mm of a lot boundary, there are specific controls over allowable building heights.

Where a neighbouring development is also within 900mm of the same boundary, new developments must not exceed the height of the neighbouring building or the maximum permissible height.

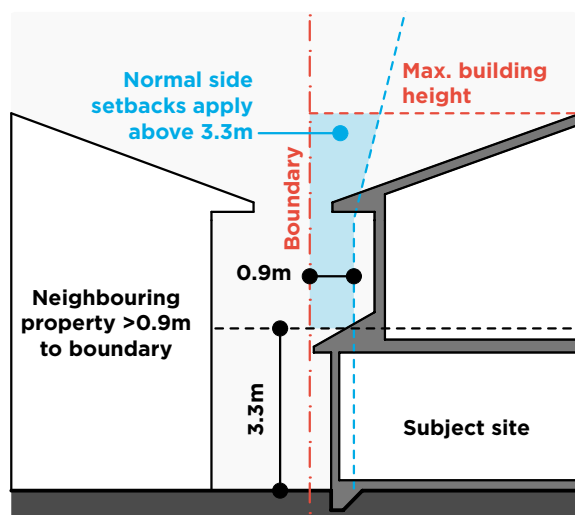

BUILT 0-0.9M TO BOUNDARY WITH NEIGHBOUR MORE THAN 0.9M FROM BOUNDARY

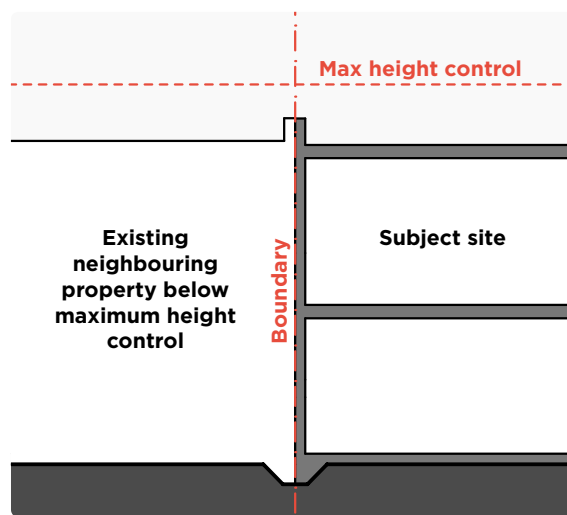

BUILT TO BOUNDARY WITH NEIGHBOUR UNDER HEIGHT LIMIT

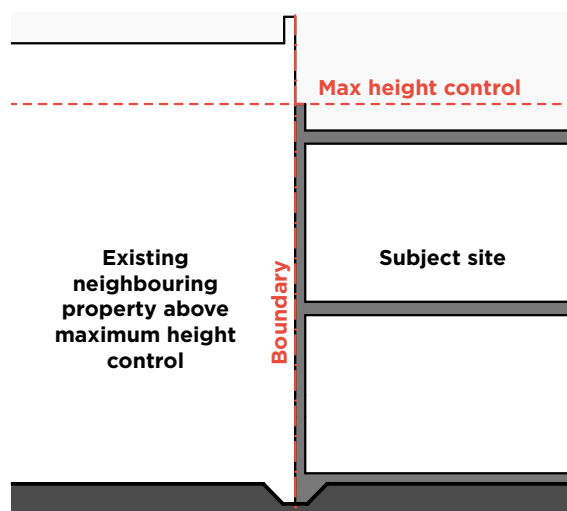

BUILT TO BOUNDARY WITH NEIGHBOUR OVER HEIGHT LIMIT

Note:

- Does not apply to Part 3A Rural Housing Code
- Specific controls and exceptions for Part 3B LRHD

External elements

Balconies, decks, patios, terraces and verandahs

Note: refer to Part 3B LRHD Code for relevant controls for low rise housing diversity projects.

A balcony, deck, patio, terrace or verandah attached to the side or rear elevation is only permitted if:

- the lot is greater than 300m²
- the lot width is greater than 10m

Floor area

The maximum combined floor area for all balconies, decks, patios, pergolas, terraces and verandahs attached to a dwelling house with a floor level more than 2m above the existing ground level and within 6m of the side or rear boundary must not be more than 12m².

How to measure floor area

The calculation of the floor area for a balcony, deck, patio, terrace or verandah means the area of the measured at the floor level within the outer face of:

- the external walls if enclosed
- the extent of the deck or balustrade or other safety barrier if not enclosed.

Some balconies, decks, patios pergolas, terraces and verandahs may be built under the Exempt Development Code.

Refer to clauses [2.11](#) and [2.12](#) of the Codes SEPP to check if your project is exempt.

Maximum height

The maximum height above ground for a balcony, deck, patio, terrace or verandah varies with the boundary setback in the table below:

Attached	
Setback from the side or rear boundary	Maximum floor level above ground (existing)
<3m	2m
3m-6m	3m
>6m	4m

Detached	
	Maximum floor level above ground (existing)
Any detached deck, patio, pergola, terrace or verandah	0.6m

Landscaped area

A lot must include at least the minimum amount of landscaped area as required by its Code.

This clause does not apply to alterations and additions with no increase in site coverage or decrease in landscaped area.

Area counted as 'landscaped area' must be at least 1.5m wide.

Note:

- Specific landscaped area controls apply to Part 3A Rural Housing Code.

Private open space

The 'principal private open space' is a recreation area such as a deck, patio or paved area which is directly accessible from a living area. It:

- has a gradient of less than 1:50
- is only required for new dwelling houses or developments that increase an existing buildings footprint or decrease the landscaped area on a lot

Note:

- Specific private open space controls apply to Part 3B for manor houses and certain dual occupancies.
- Part 3D Inland Housing Code does not contain private open space controls

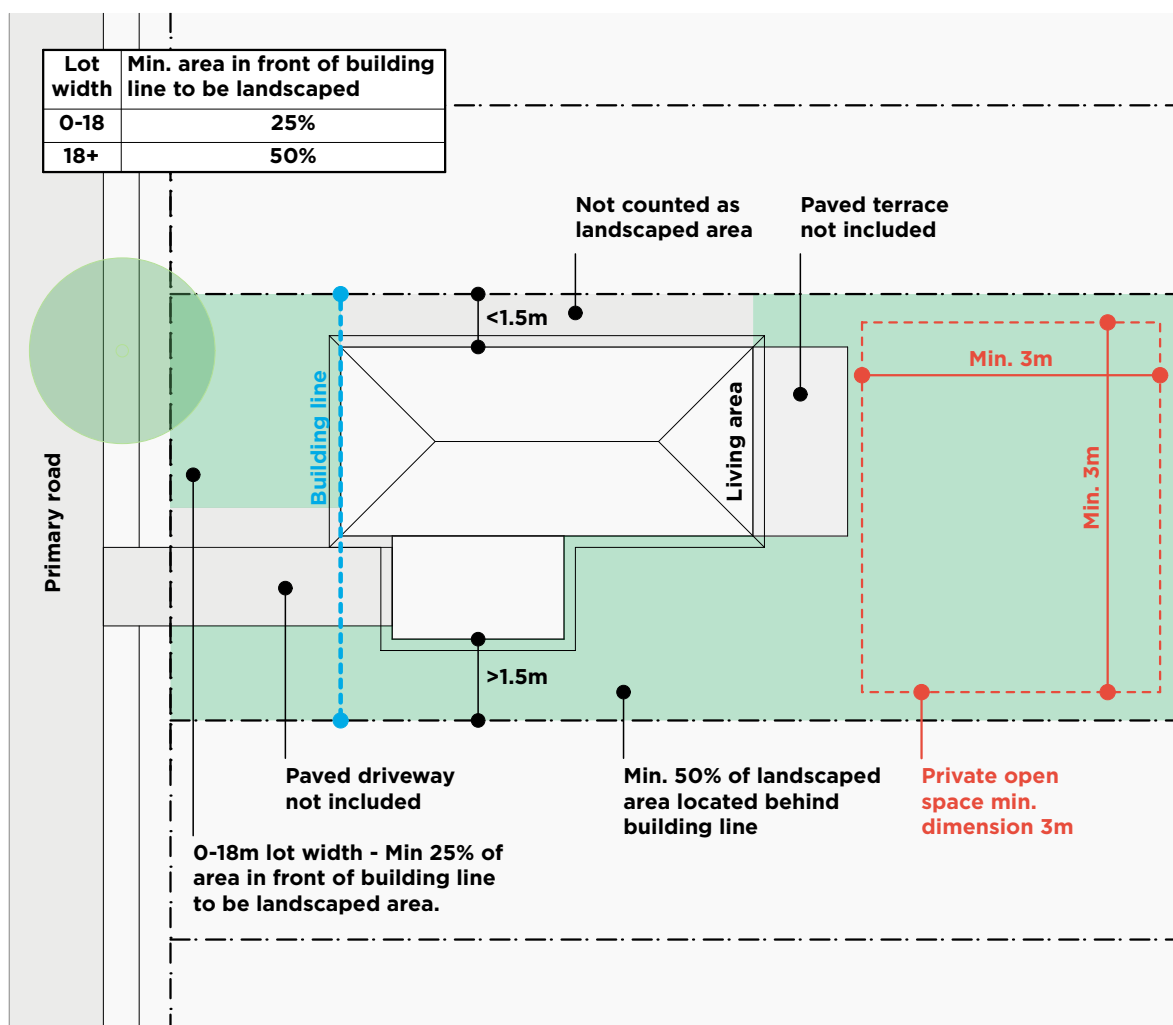

Trees

Tree removal and pruning

Trees or other vegetation on a lot may only be removed or pruned if:

- the tree is not listed on a register of significant trees by the local council, and
- the tree or vegetation will be within 3m of any new building over 25m² and
- the tree or vegetation has a height less than 8m for the erection of a house or 6m in other cases.

Tree protection

New development must have a minimum 3m setback from the base of the trunk of any protected tree.

Development can occur within 3m of a protected tree if:

- it does not involve the excavation or fill of more than 150mm, and
- is for the construction of:
 - an access ramp
 - a driveway, pathway or paving
 - an awning, blind
 - canopy, a fence, screen, or pool fence

The purpose of this clause is to preserve trees that are otherwise unaffected by new building works.

Note: A separate permit or council approval may be required if branches or roots of a tree on an adjoining lot requires to be pruned or removed.

Protected tree means a tree that requires a separate permit or development consent for pruning or removal. [clause 1.5](#)

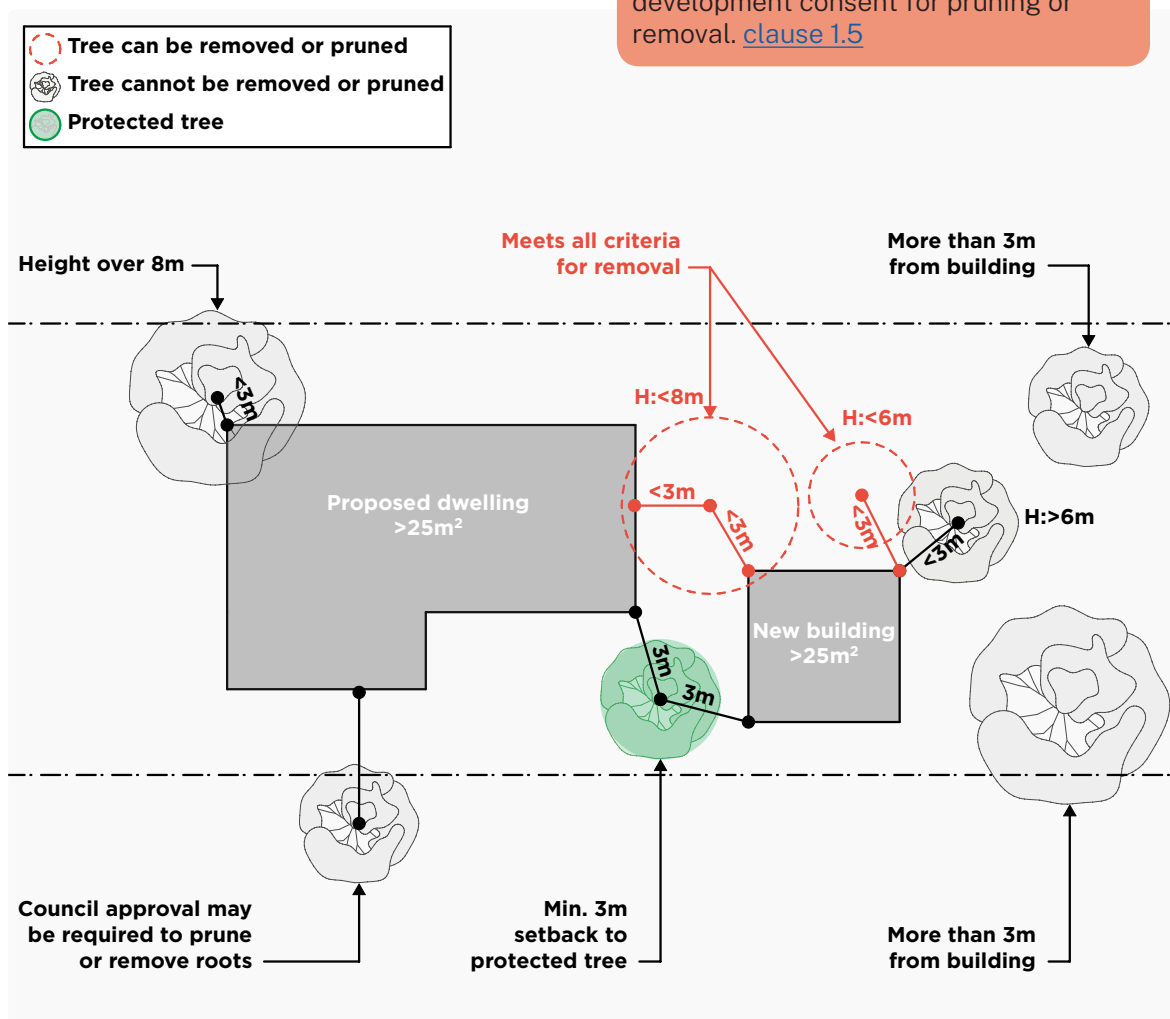

Swimming pools

Pools must be for private use and associated with a dwelling house.

Swimming pools must be located in the rear yard or behind the front building line.

The water line must be setback at least 1m from a side or rear boundary.

The pool coping is to be a maximum 1.4m above existing ground level and have a maximum width of 0.3m if it is more than 0.6m above the existing ground level.

Decking associated with a pool is to be a maximum 0.6m above the existing ground level.

Waste waters from the pool must be discharged in accordance with the relevant authority's requirements.

Pumps associated with the pool must be located in a soundproof enclosure.

Swimming pools can only be undertaken as complying development on a lot with an existing dwelling house or in conjunction with a new dwelling house.

If the swimming pool is to be constructed in a heritage conservation area it must be located behind the building line of the adjacent property and no closer to each side boundary than the dwelling house.

Note:

- Part 3B LRHD contains an additional control that a pool may not be able to be filled to more than 1.2m above existing ground level

Note: Refer to the BCA and Australian Standards for pool and pool fencing design codes and requirements.

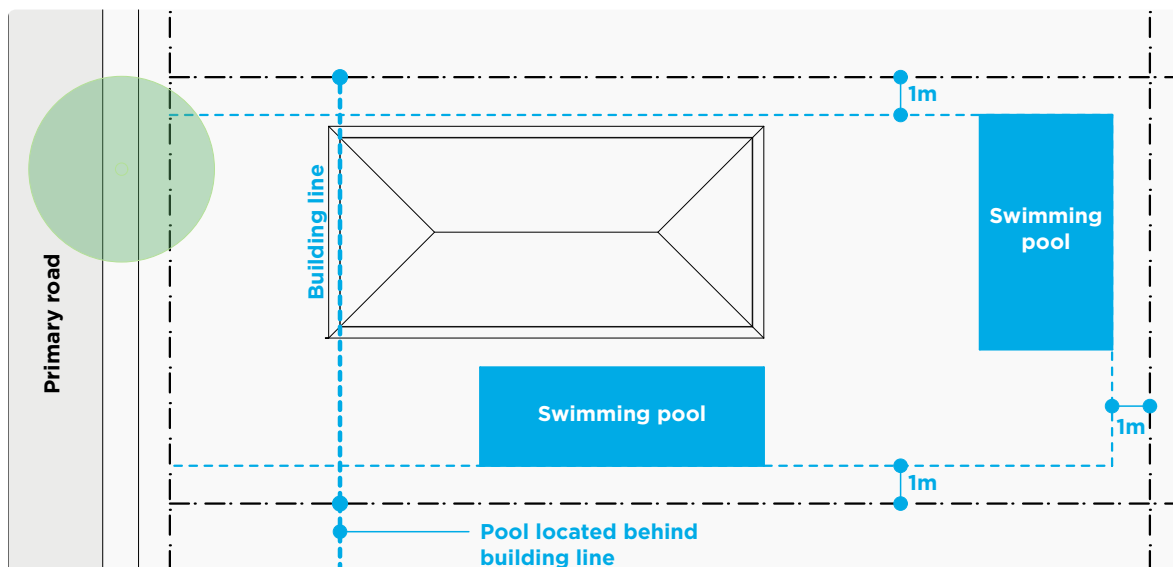

SWIMMING POOL LOCATION - PLAN

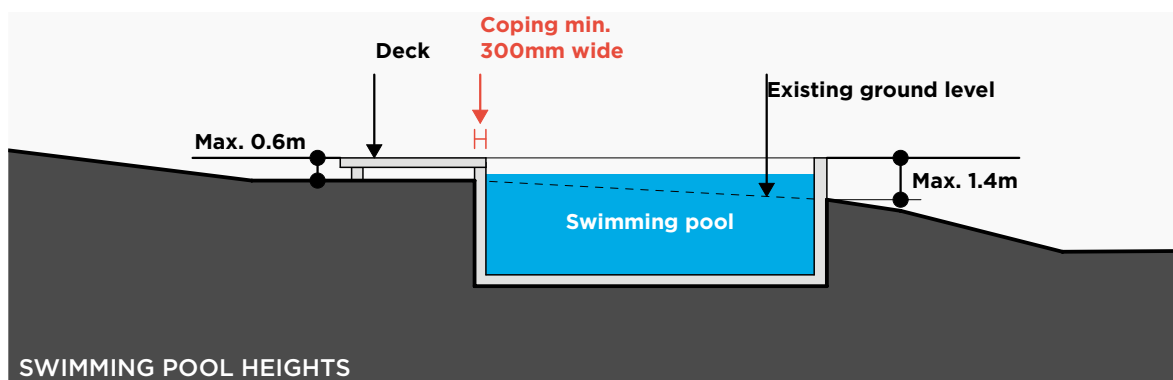

SWIMMING POOL HEIGHTS

Fences

Fences cannot be erected under this code on:

- a lot or boundary that bounds a heritage item or draft heritage item, or
- along a boundary of, or within the setback of a primary or secondary road within a heritage conservation area or draft heritage conservation area

Fences within the front setback area of a primary or secondary road are to be:

- a maximum 1.2m high
- a minimum 20% open construction above 400mm high with a minimum 25mm aperture
- solid elements above 400mm being no more than 350mm wide

Fences behind the building line are to be:

- a maximum of 1.8m high
- on stepped sites, the highest point of the fence must not be greater than 2.2m above the ground level

All fences must:

- not incorporate barbed wire
- not be electrified
- if includes an entrance gate, not swing outwards
- if constructed of metal, be low reflective, factory pre-coloured materials
- not restrict the flow of any floodwater and confirmed by a hydraulic and civil engineer.
- be constructed of non-combustible material in bush fire prone land

Note:

- Does not apply to Part 3A Rural Housing Code

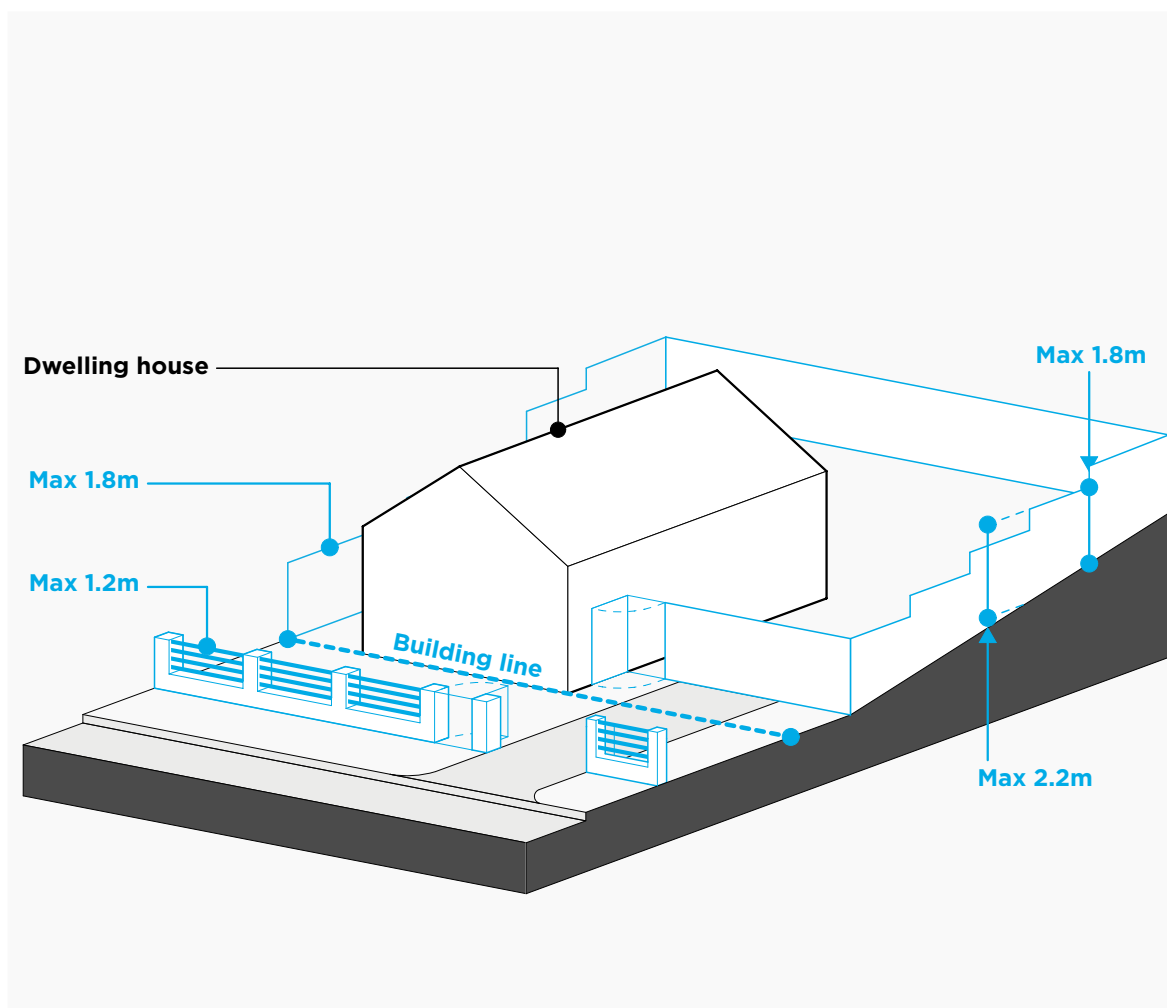

Amenity

Windows, doors and openings

Standard and parallel lots

A dwelling house must have at least -

- 1 window to a living area or a bedroom ('habitable room'), and
- 1 door -

facing the primary road or parallel road.

Corner Lots

A new dwelling house on a corner lot must have a window to a living area or a bedroom ('habitable room') of at least 1m² that faces and is visible from the secondary road.

Heights of building elements

Building elements other than an entry feature or portico that have the same pitch as the roof, must not extend more than:

- 1m above the gutter line of a single storey dwelling or
- the gutter line of a 2 storey house

Note:

- Does not apply to Part 3B LRHD Code.

Note: clause 3.14 excludes battle-axe blocks

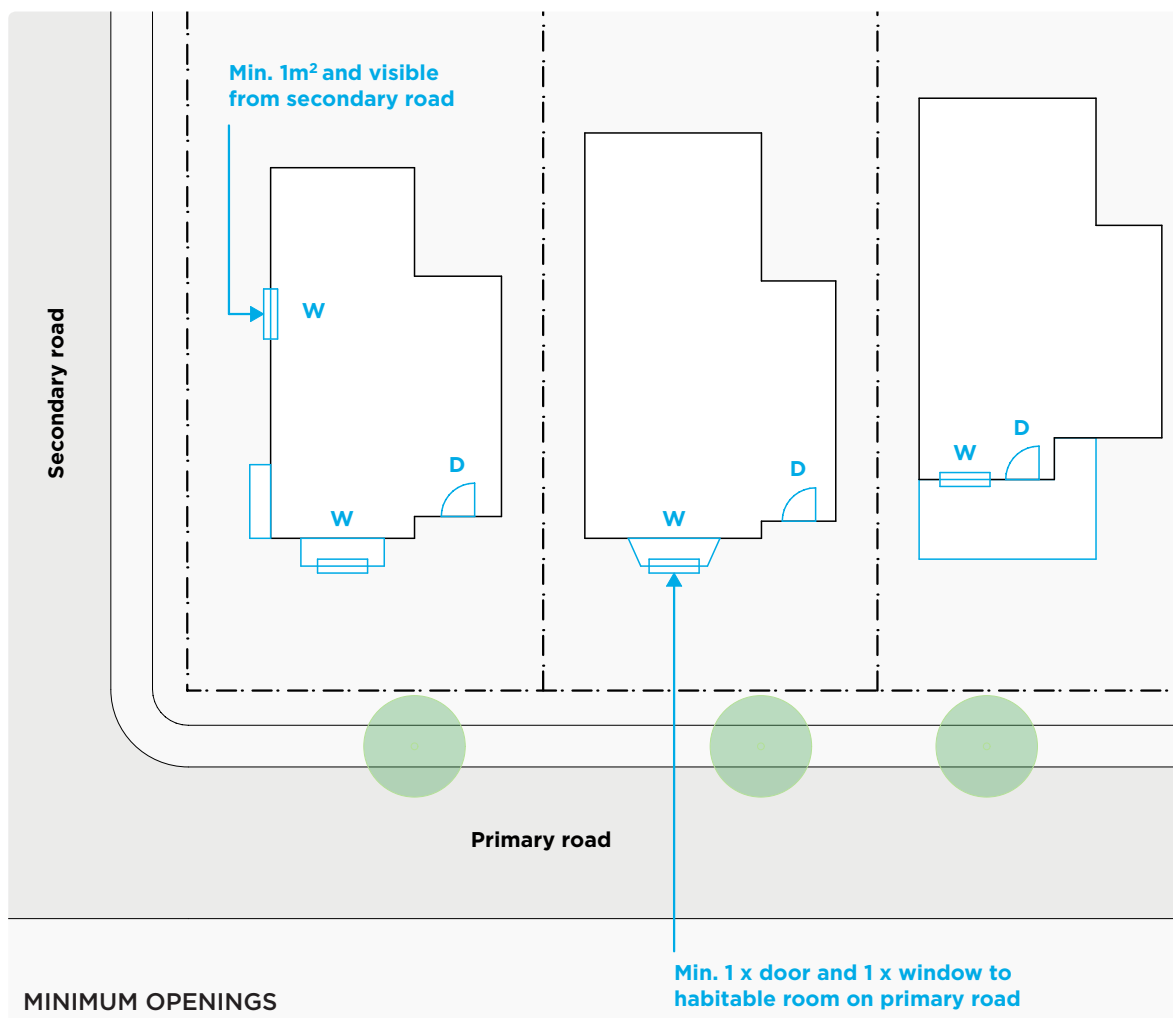

Articulation - new dwelling houses

Primary road frontage

An 'articulation zone' may be used within the front setback where the dwelling has a primary road setback of at least 3m.

This zone is a notional area projecting 1.5m forward of the front building line within which additional building elements such as entry features and porticos, balconies, decks, verandahs, and bay windows may be built.

Up to 25% of the articulation zone may include building elements.

Note:

- Part 3A - articulation zones apply only to lots in Zone R5 less than 4,000m²
- Part 3C - sites 200-300m² have min primary road setback of 3m, so articulation zone can be min 1.5m setback from primary road

Building articulation

(secondary road on corner lots)

Where the dwelling house is set back 4.5m or less from a secondary road, corner lots must incorporate one of -

- an entry feature or portico
 - a balcony, deck, pergola, terrace or verandah
 - a bay window
 - a step of at least 600mm in depth
- for a minimum of 20% of the wall length.

These elements may be located within the articulation zone if the zone extends no more than 1m into the required minimum setback and spans the length of walls that face the secondary road. The building articulation must comprise of no more than 20% of the zone area.

Any part of a gable or hipped roof that overhangs walls that are within 4.5m of a secondary road boundary must include eaves that are 0.45-1m.

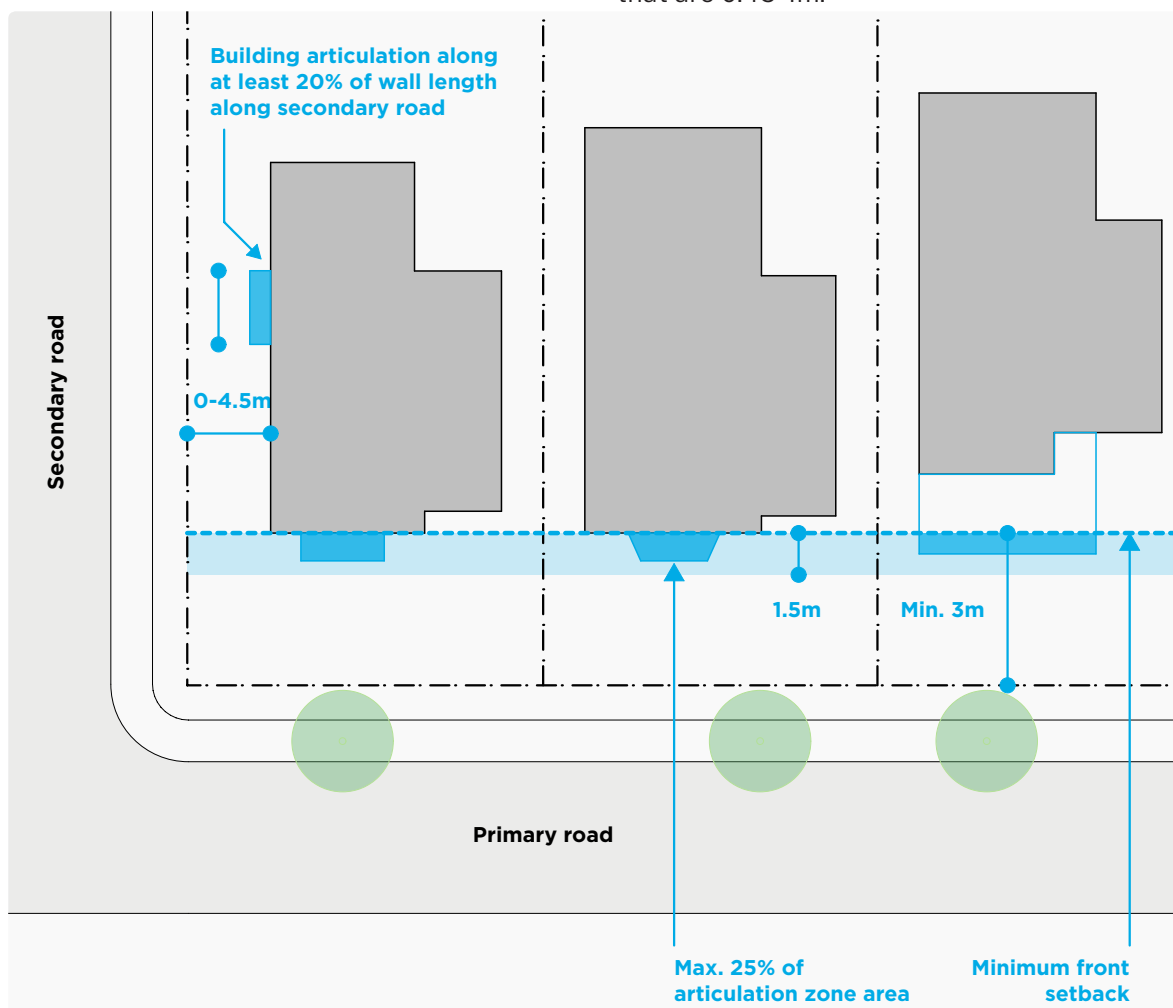

Privacy screens

Privacy screens: windows

A new window must have a privacy screen as per the table below.

Habitable window side or rear setback	Room height above ground level	Privacy screen required
<3m	<1m	No
<3m	>1m	Yes*
3-6m	<3m	No
3-6m	>3m	Yes*

*Not required for bedroom windows of less than 2m²

Privacy screens: balconies, decks, patios, terraces and verandahs

A new or addition to an existing balcony, deck, patio, terrace and verandah must have a privacy screen of 1.7-2.2m high on the edge that faces the relevant boundary if it:

- has a floor area more than 3m², and has a setback of less than 3m from a side or rear boundary and a level more than 1m above existing ground level, or
- has a setback of 3-6m and a level more than 2m above ground level (existing)

A privacy screen means a screen that:

- faces the boundary
- has openings less than 30mm wide,
- has a total area of all openings less than 30% of the surface area of the screen, or is a fixed un-openable window with translucent glass.

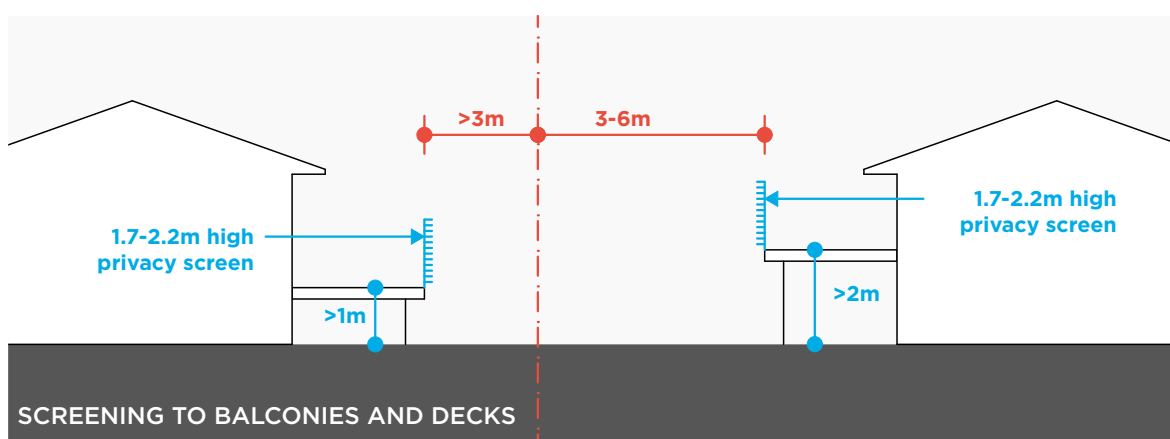
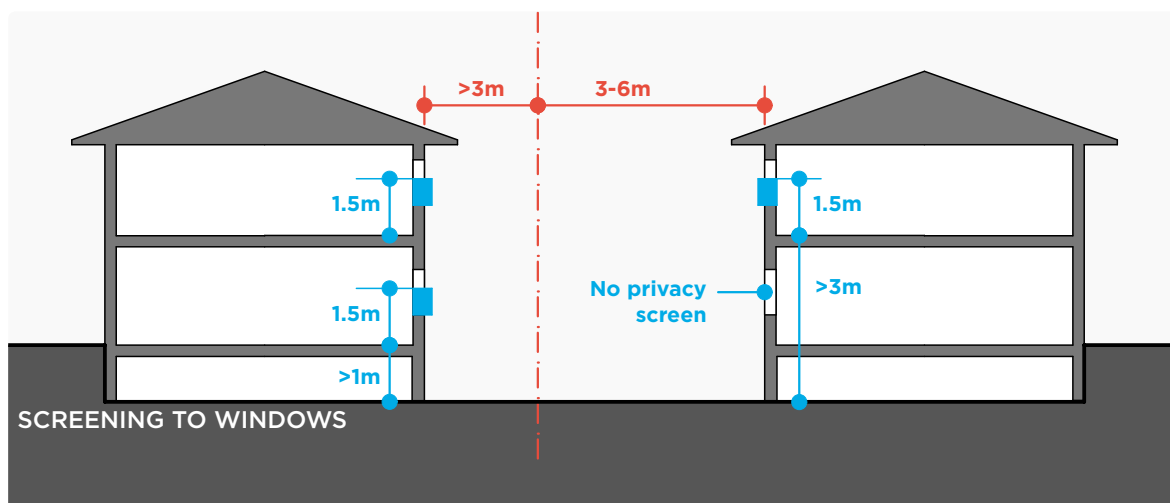

Car parking and access

Applies to:

- Part 3 Housing Code
- Part 3C Greenfield Housing Code

Site detail	Control
Lot width >8m	Min 1x car space
Lot width <8m	A garage may only be built if accessed off secondary road, parallel road, or lane
Battle axe lot	vehicles must leave in a forward direction
Alterations and additions to existing dwelling with carspaces	At least 1 car space must be retained

Lot width	Maximum width of garage door openings
8m-12m	3.2m
>12m	6m

A car parking space may comprise of a garage, carport or open car parking space.

Car parking spaces, attached or detached are required to be setback at least 5.5m from the road boundary and at least 1m behind the building line.

Alterations or additions to a garage or carport that is forward of the building line is not complying development under this code.

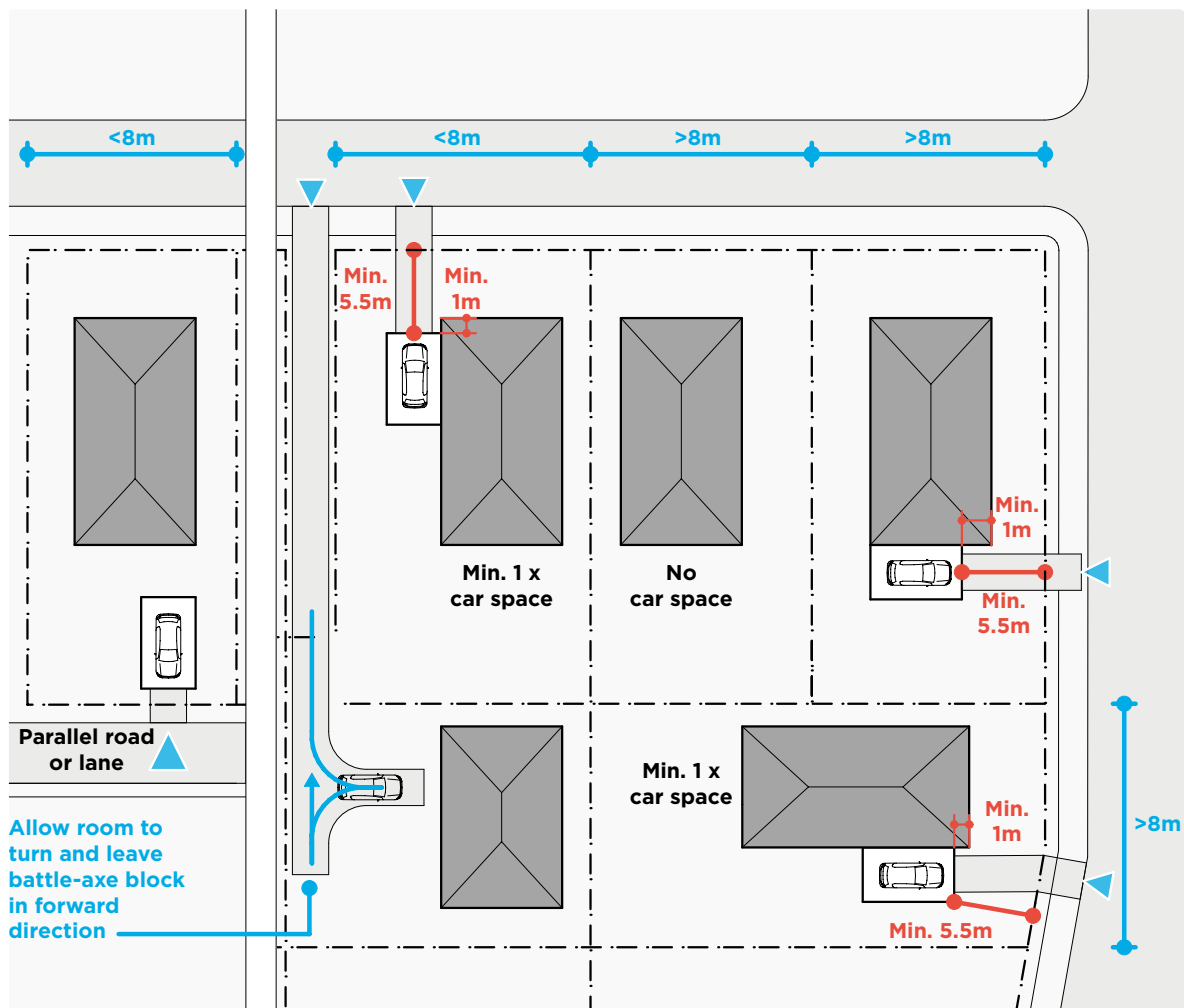

Earthworks, retaining walls and drainage

Excavation

Distance from boundary	Maximum excavation depth
<1m	1m
1m-1.5m	2m
1.5m-3m	3m

For sites located in Class 3 or 4 on the Acid Sulfate Soils Map or within 40m of a waterbody, excavation must not exceed 1m. Refer to your 10.7 planning certificate for Acid Sulfate Classification.

Fill

Fill must not be higher than:

- 1m when used to construct the house
- 0.6m in all other instances
- not limited if contained wholly within the building footprint or a drop edge beam

Depth of fill outside built footprint	Maximum area
<150mm	unconstrained
>150mm	50% of landscaped area

Note: The new ground level as a result of fill cannot be used to measure heights under this code. The existing ground level must be used.

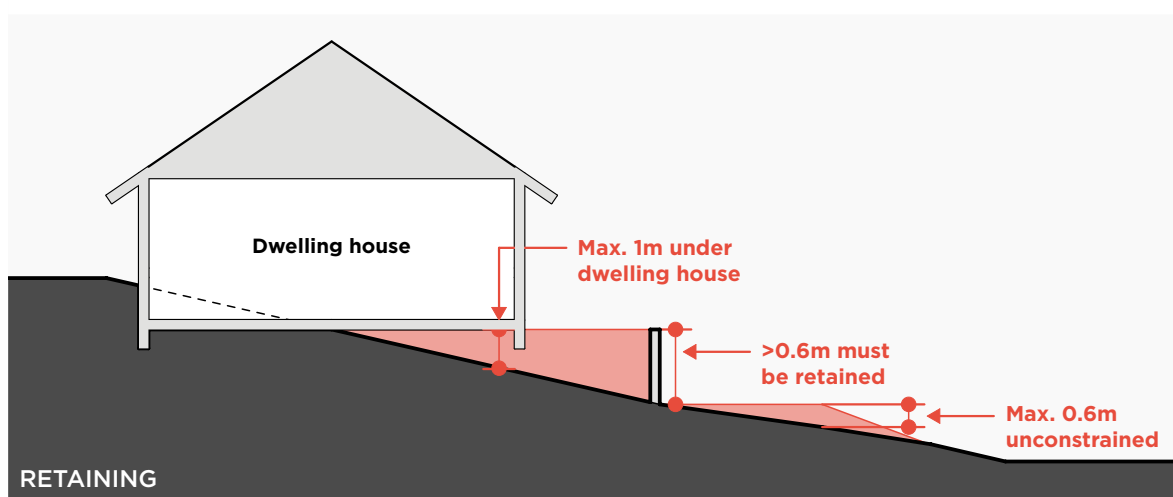
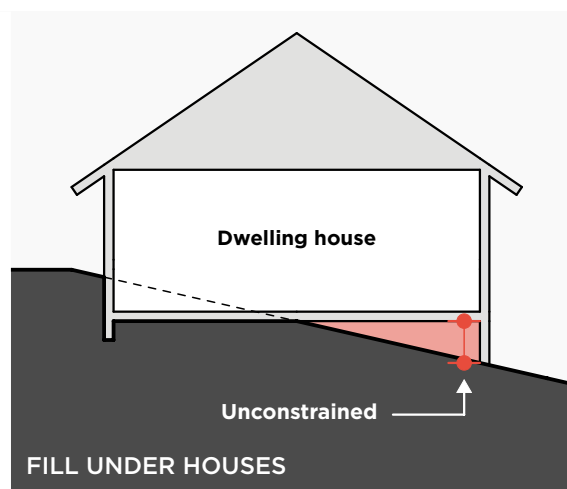
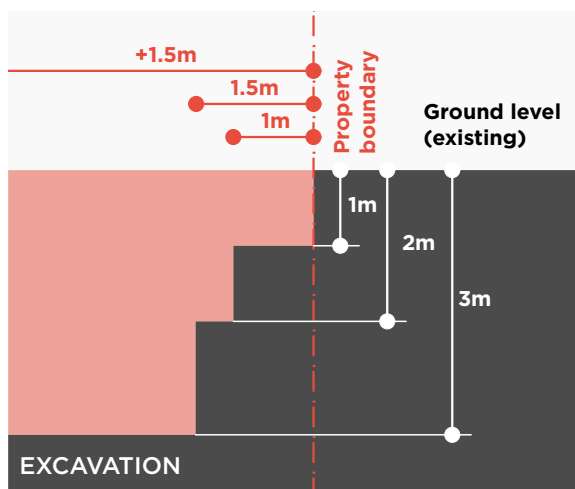

Retaining walls

A retaining wall supporting earthworks more than 600mm must:

- be certified by an engineer
- not redirect the flow of water or sediment onto an adjoining property
- have adequate drainage lines connected to stormwater drains
- not be taller than the excavation or fill being retained
- be separated by at least 2m from any other retaining wall or structural support
- if it is an embankment or batter, have a top or toe that is more than 1m from a side or rear boundary

Drainage

All stormwater and surface water run off collecting as a result of the construction of the works must be conveyed by a gravity fed or charged system to either the:

- public drainage system
- inter allotment drainage system, or
- on-site disposal system where approved

Connection to a public or inter-allotment drainage system must:

- comply with the requirements of DCP applicable to the land, or
- where approval is required under section 68 of the Local Government Act, seek approval from council

Step 5

Satisfy all other requirements



Conditions and other requirements for complying development

Conditions

Applicants will need to comply with the conditions set out in the Codes SEPP. The conditions set out the

applicant's obligations once a Complying Development Certificate has been issued.

While they generally outline obligations before, during and after construction, it is a good idea to familiarise yourself with them prior to lodging your application.

There are also several conditions that may impact the design of your project.

The conditions that apply to each Code:

Part 3 - Housing Code

Part 3A - Rural Housing Code
Part 3D - Inland Code

- [Schedule 6](#)

Part 3C - Greenfield Housing Code

- [Schedule 6](#), and
- [Clause 3C.37](#) additional conditions

3C.37 (4) stipulates that two trees must be planted for new dwellings prior to completion of the works. This may affect your site planning and should be considered during the design phase.

Part 3B - Low Rise Housing Diversity Code

- [Schedule 6A](#)

Schedule 6A (28) stipulates trees must be planted prior to completion of the works. This may affect your site planning and should be considered during the design phase.

Part 4 - Housing Alterations Code

- [Schedule 7](#)

Day House, Architect: Allied Office
Photographer: Tom Ferguson



Notify your neighbours

In some cases it is mandatory to notify your neighbours of your proposed development. It is recommended you talk to your neighbours before receiving an approval and again before you commence construction.

If you're looking to go down the complying development route, there are two required neighbour notifications:

1. Pre-approval notification

Talking to your neighbours about your development proposal, big or small, is always a good idea and often saves a lot of trouble down the track. The Department encourages talking to your neighbours as early as possible in the design process to help ensure the development process is as smooth as possible for all involved and doesn't come as a surprise.

Note: The pre-approval notification is carried by your certifier (private or council) not by yourself.

Metropolitan areas:

A certifier (private or council) is required to inform neighbours within a 20 metre radius that you have applied for a complying development certificate 14 days before it can be approved. This is called pre-approval notification.

Neighbour notification must be in writing, the notice may be given in person, through a letter box or via the post. If a lot contains an apartment building or is a dual occupancy, the occupier of each individual home/apartment must be notified.

Neighbours can request to see the plans of the complying development, however, there is no obligation for the applicant to make these available.

Outside of metropolitan areas:

While there is no formal pre-approval notification required, it is still a good idea to make your neighbours aware of any development proposals.

Details of which areas notification may be found in the [EP&A Regulation Clause 134 Notice to neighbours](#)

2. Pre-construction notification

Once your complying development certificate has been issued, you must notify neighbours within 20 metres from the boundary of the development lot, prior to any work commencing.

This is called pre-construction notification. This notice is for their information only, neighbours cannot make a submission on a neighbouring complying development.

Metropolitan areas:

If you live in a metropolitan area, you must give your neighbours at least seven days' notice.

Outside of metropolitan areas:

If you live in rural and regional areas or a residential release area, you must give your neighbour two days' notice. It is the applicants' responsibility to notify neighbours before construction begins and this must be done in writing.

If you would like more information about which complying developments require notification; which properties you should notify; and whether you live in a metropolitan, regional and rural area or a residential release area; view the fact sheet

["Your guide to neighbourhood consultation for complying development."](#)

BASIX

If you're building a new home, undertaking renovations of \$50,000 or more, or installing a pool or spa of more than 40,000 litres, you will need a BASIX certificate.

BASIX sets key standards for energy reduction, water use reduction and for thermal comfort. Alongside selection of fixtures and appliances, site planning, orientation, and construction materials, will contribute to your BASIX assessment.

Further information about BASIX can be obtained at the [BASIX website](#).

Building Code of Australia

The Building Code of Australia sets out the mandatory construction requirements that must be complied with for all building projects. It is free to download from the [National Construction Code website](#).

The relevant documents for a complying development are:

- Volume One: Class 2-9 buildings
- Volume Two: Class 1 and 10a buildings the relevant classifications for this Guide:
 - Class 1 buildings are detached dwellings, or a group of two or more attached dwellings (eg terraces).
 - Class 10a buildings are non-habitable buildings including a private garage, carport, shed or the like.
 - A Class 2 building is a building containing two or more sole-occupancy units (eg. a manor house).

Items to double check

Double check your application, including Steps 1-4 of this Guide.

Double check to see if any variations to the Codes SEPP ([Schedule 3](#)) apply to your land.

Part 1 of the Code SEPP (covered in Step 3 of this Guide) contains many easy to miss considerations, including:

- [Clause 1.18 \(1\)\(d\)](#) - make sure you have written approval for an on-site effluent disposal system (where no sewer) and on site stormwater drainage system.
- [Clause 1.18 \(1\)\(e\)](#) - make sure you have written approval for any kerb, crossover, or driveway.
- [Clause 1.18 \(1\)\(h\)](#) - make sure you have a permit for any pruning or tree removal requiring a permit.
- [Clause 1.18 \(2\)](#) - if you are in 20-25 ANEF, check compliance with AS 2021:2015.

STEP 5 CHECK

Have you:

- appointed a certifying authority? Either a private certifier, or your local council
- read the relevant conditions and included any necessary detail to your application
- prepared a BASIX certificate
- discussed your proposed works with your neighbours
- double checked if any variations to the Codes SEPP apply to your land,
- double checked you have the required permits or approvals (eg. driveway crossovers),
- confirmed compliance with the BCA, and any applicable Australian Standards (eg for aircraft noise)



Proceed to STEP 6

Step 6

Satisfy all other requirements

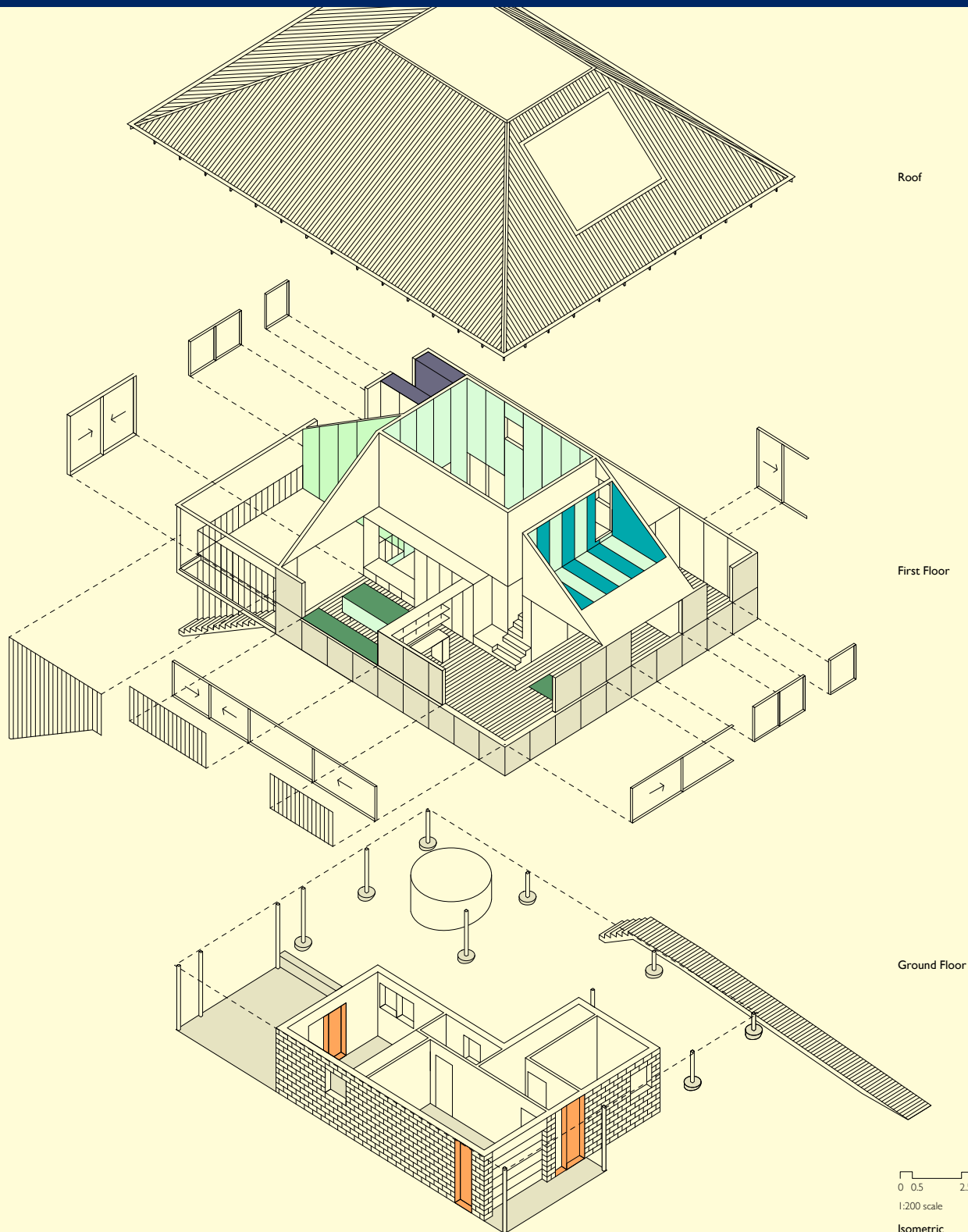

Submit a complying development application

Once you have prepared all the documentation required for the complying development certificate application, you are ready to submit it for approval.

Your application will be submitted through the [planning portal](#).

Click “My Account” in the top right corner to begin the process. If this is your first time using the Planning Portal, you will be prompted to make an account.

If the online CDC application service is not yet available in your area, you can apply directly to your local council or search for a registered certifier on the Building Professionals Board’s Register.

A NSW Government website My Account

NSW GOVERNMENT NSW Planning Portal Q

BASIX Certificate ▾ Short Term Rental Accommodation ▾ Development Assessment ▾ Post-Consent Certificates ▾ APIs & Reporting ▾ Planning Panels ▾ Exhibitions & Publications ▾ Support Training ▾

Changes to the state significant project application process

Get ready - from 1 July 2022, most Environmental Impact Statements for state significant project applications will need to be reviewed by a registered environmental assessment practitioner (REAP).

→

Looking for planning information about a property? Find a Property

Planning Portal entry page

Steps to submit a CDC application

To submit a CDC application, there are up to six steps that must be completed:

1. Applicant details

- primary applicant's personal details, such as your name and contact details
- details of all the site's owners
- developer's details, such as the company name and ABN.

2. Development details

- application type: CDC or a modification to an existing CDC
- the site of your development using the address or Lot /Section number/Plan
- proposed development type(s) from the list: for example, dwelling house, secondary dwelling, dual occupancy
- a detailed description of the development that you are proposing.
- estimated area of bonded asbestos removal in square metres
- the estimated cost of work /development including GST
- lot type: corner lot, parallel road lot, battle-axe lot, standard lot
- BASIX certificate details
- indicate if approval under s68 of the Local Government Act 1993 is required
- if yes, you may be able to apply through the Planning Portal. Follow the application prompts and complete the corresponding fields and complete this application before finalising the CDC application.

3. Practitioner details

(class 2 developments only)

If a class 2 development type is selected, such as dwellings under Part 3B Low Rise Housing Diversity Code, or work on an apartment under Part 4 Building Alterations Code, there are additional obligations in accordance with the *Design and Building Practitioners Act 2020*.

- nominate the design practitioners
- include a Building Work Commencement date after the CDC is determined

4. Certifier details

- identify the principal certifier and insert their company name, trading name, ABN or CAN.

5. Requirements and uploads

- select or drag and drop your files, which may include drawings, reports, and your BASIX certificate.

6. Review and complete

- review all your application information
- complete the declarations and submit your CDC application.

Once you submit your application through the Planning Portal, it will be sent to the nominated certifier for review and they will discuss payment and any additional requirements with you directly. Where neighbour notification is required, the certifier will complete this.

A decision on the outcome of your CDC application should be received within 20 days of you completing and submitting your application.



Appendices



Required documents

Your certifying authority will provide you with a checklist of documents required for the assessment of the CDC application. Depending on your project, additional drawings, studies, or information may be required.

An example of what you will need to include:

Required documents	
Architectural plans	<p>Architectural plans are to scale plans which show the architectural elements of the proposed building and works.</p> <p>The plans are to detail all works at an appropriate scale, and provide detailed floor plans including:</p> <ul style="list-style-type: none"> • north point • room names • all building elevations with external finishes and colours noted • sections • height of buildings and floors • external finishes, • finished levels of the development and relative to the surrounding land • the street and neighbouring properties • BASIX and fire safety elements • proposed landscaping • vehicular arrangements (parking areas, drives) • waste management (where bins are stored) • water storage, water tanks, on site detention
Site plan	<p>A site plan illustrates the whole development and shows all features on the site and adjoining land including structures and buildings, access driveways, roads and landscaping.</p> <p>The site plan will include:</p> <ul style="list-style-type: none"> • a north point • site boundaries and dimensions • proposed and existing buildings (including any proposed extensions) • setbacks to boundaries • existing vegetation and whether proposed to be retained or removed • indicative areas open space and landscaping, • parking, and driveways • footpaths, indicative drainage arrangements (if required)

	The site plan should additionally include contours (at 1.0m intervals, or at 0.5m if the site is less than 1000m ²), services and easements locations, and proposed finished levels relative to adjoining land and roads.
Specifications	<p>A detailed description of the proposed development materials and finishes (including details of new and any second-hand materials) and the method of drainage, sewerage and water supply.</p> <p>The description will also include the height, design, construction and provision for fire safety and fire resistance (if any), and the matters which the BASIX certificate for the development requires to be included in the plans and specifications.</p>
Structural plans	A structural plan is produced by a structural engineer, to provide details of the structural capacity of the proposed work.
Additional documents	(that may be required)
Accredited building product/system	This means a building product or system accredited as complying with a requirement of the Building Code of Australia.
Approved CDC details	
BASIX Certificate	The BASIX certificate prepared for the project
BCA performance requirements compliance statement	To enable the certifier to be satisfied with the development, the applicant must provide information to demonstrate that the development has the capacity to comply with the Building Code of Australia e.g. the provision of engineer reports for works within 0.9m of the boundary or details of any alternative solution, to meet the required performance requirements.
Building upgrade report	A building upgrade report provides details of the existing building, and details any proposed building work to alter, expand or rebuild an existing building.
Certificate of Title	A certificate of title is a document for a land holding that records all details and interests affecting that land such as easements, covenants, mortgages, resumptions, caveats and subsequent changes of ownership.

Compliance certificates relied on engineering report regarding support of adjoining wall	<p>In order to verify the appropriateness of certain building work, it is sometimes required to provide a compliance certificate.</p> <p>For example, the EP&A Regulations require compliance certificates to be obtained for certain fire safety aspects of development before a CDC, CC or occupation certificate can be issued and require compliance certificates to be obtained for certain alternative solutions to the BCA before a complying development certificate can be issued.</p> <p>Compliance certificates may be issued to demonstrate that detailed designs comply with conditions of approval or that works have been properly executed in accordance with an approval.</p>
Design verification statement	<p>A design verification statement is required for complying development (including alterations and additions) for:</p> <ul style="list-style-type: none"> • a dual occupancy • manor house • multi dwelling housing (terraces) <p>It is a statement prepared by a registered architect or a person accredited as a building designer by the Building Designers Association of Australia that –</p> <ol style="list-style-type: none"> (i) verifies that he or she designed, or directed the design of, the development, and (ii) addresses how the design is consistent with the relevant design criteria set out in the Low Rise Medium Diversity Design Guide for Complying Development.
Documentation for temporary structure	<p>The purpose of a temporary structure report is to enable assessment of the safety of placing temporary structures on a site, considerations may include fire safety measures, maximum loads, BCA compliance and number of persons using the structure.</p>
Bush Fire Protection Measures	<p>Planning for Bush fire Protection , 2019 - A range of measures used to minimise the risk from a bush fire that need to be complied with. BPMs include APZs, construction provisions, suitable access, water and utility services, emergency management and landscaping.</p> <p>These measures should relate to any BAL Risk Assessments Certificate which has been issued in relation to the development.</p>
Other documents	<p>To complete the assessment of your development, your registered certifier may require additional documentation. Your registered certifier will advise you if this is the case. Generally, the additional information will relate to the attributes of your site eg Acid sulfate soil classification, bushfire prone land status, flood affectation.</p>

Owner's consent	A document which provides evidence that the owner of the land on which the proposal is to be carried out consents to the application.
RMS traffic impact statement	<p>The purpose of a RMS Traffic Impact Statement is to evaluate the impact of the proposed development on the traffic network and to justify the proposed car parking provision and traffic movements within, and into and out of, the site. The report is prepared by a traffic engineer.</p> <p>A traffic impact statement should be prepared in accordance with the Roads and Maritime Services Guide to Traffic Generating Development (2002).</p>
Scaled plan of existing buildings	This is a plan drawn to scale of existing buildings on the development site and on adjoining sites. Existing vegetation and driveways/hardstand areas should also be shown on the plan. Common scales used for building plans include 1:100, 1:200 and 1:500.
Section 10.7 Planning Certificate EP & A Act (formerly Section 149)	<p>A planning certificate, also known as a section 10.7 certificate, is a legal document issued under the Act that provides information about the planning rules, and whether various restrictions apply to development on that land.</p> <p>Planning certificates are available on application from the local council.</p>
Section 138 Roads Act approval	<p>Under Section 138 of the Roads Act 1993 the consent of the appropriate roads authority (Transport for NSW or the local council) is required to:</p> <ul style="list-style-type: none"> • erect a structure or carry out a work in, on or over a public road, (eg a skip bin placed on the road) • dig up or disturb the surface of a public road, or (eg to cut in a new driveway) • remove or interfere with a structure, work or tree on a public road, or (eg trim a street tree) • pump water into a public road from any land adjoining the road, or (eg stormwater) • connect a road (whether public or private) to a classified road (eg driveway) <p>If the development is on a classified road then approval is required from Transport for NSW - a section 138 permit is required.</p> <p>If the development is not on a classified road then a section 138 permit is required from the local council.</p> <p>note: An approval under the Table to Section 68 of the Local Government Act is also required (unless there is a Local Approvals Policy (under the LG Act) to allow placement without approval.</p>

Site contamination statement	This is a report by a contaminated land specialist in accordance with SEPP – Remediation of Land (SEPP 55). The report is required if the development is on land identified as land requiring a preliminary investigation report before a DA for development on that land can be determined.
Soil and water management plan	A soil and water management plan is a plan which outlines the measures to be implemented to control erosion and sedimentation on a development site. The plan details the specific methods of erosion and sedimentation control that will be used at the various stages of construction.
Stormwater management plans	A stormwater management plan is a plan drawn by a stormwater engineer that enables assessment of the stormwater system needed to appropriately manage stormwater runoff from a development site. The plan will also identify stormwater reuse, water quality and quantity management facilities to be used on the site and connections to available services and easements.
Survey plan	<p>A survey plan documents the existing site features, topography and built form on a development site, and on adjoining properties.</p> <p>The plan will include:</p> <ul style="list-style-type: none"> • a north point • detail the site area and boundary dimensions • show the existing buildings, structures and other notable features on the site, and on adjoining sites. • the site’s topography (spot levels, contours) and that of the adjoining properties • any easements or rights of way • existing vegetation (indicating its location, type and spread)
Tree removal permit	<p>The provisions of SEPP - Vegetation in Non-Rural areas 2017 and/or the development control plan (DCP) of a local council may allow pruning or removal of a tree on private land without consent.</p> <p>It is essential to find out from the relevant local council whether any proposed pruning or vegetation removal requires a tree removal permit or a development application. Many councils have information on their websites regarding the criteria applicable to determining whether the removal or pruning of a tree requires a permit or consent or may be exempted from those requirements.</p> <p>Where a tree removal permit is required, the application form can be obtained from the local council.</p>

Acronyms and Abbreviations

ANEF	aircraft noise exposure forecast
BAL	bush fire attack level
BASIX	building sustainability index
BCA	Building Code of Australia
CC	construction certificate
CDC	complying development certificate
	Codes SEPP State Environmental Planning Policy (Exempt and Complying Development Codes) 2008
DA	development application
DCP	development control plan
DPIE	Department of Planning, Industry and Environment
EP&A Act	Environmental Planning and Assessment Act 1979
EP&A Reg	Environmental Planning and Assessment Regulation 2021
GFA	gross floor area
HCA	heritage conservation area
LEP	local environmental plan
LGA	local government area
LRHD	low rise housing diversity
NCC	National Construction Code
OC	occupation certificate
PC	principal certifier
SEPP	State Environmental Planning Policy

Photo credits

Page	Project	Architect	Photographer
Cover	Jac House	Panov Scott	Brett Boardman
ii-iii	-	-	DPIE
iv	Riverview House	David Boyle	Brett Boardman
Introduction Cover	Riverview House	David Boyle	Brett Boardman
3	Pompeii	Carter Williamson	Katherine Lu
3	Mosman Minka	Downie North	Katherine Lu
3	Putney Hill	Cox	Martin Mischkulnig
3, Step 2 cover	Day House	Allied Office	Tom Ferguson
3	Kingsford House	GSBN	GSBN
3	Allen key House	Studio Prineas	Chris Warnes
3, 2-2	Hole in the Roof House	Neeson Murcutt	Brett Boardman
3	Denney House	Sam Crawford	Brett Boardman
3	Gipps Street House	Scale	Matt Chan
7	Breezblock House	Studio Prineas	Katherine Lu
Step 1 Cover	Willoughby House	Sam Crawford Architect	Brett Boardman
Step 2 Cover	Day House	Allied Office	Tom Ferguson
2-2	Hole in the Roof House	Neeson Murcutt	Brett Boardman
Step 5 Cover	Mosman Minka	Downie North	Katherine Lu
5-5	Day House	Allied Office	Tom Ferguson
Step 6 cover	Narooma Courtyard House - AXO	Aileen Sage	Aileen Sage
Appendices cover	Lilyfield House	Retallack Thomson	Benjamin Hosking

Glossary of terms

A selection of important and relevant terms from the Codes SEPP. [The full list of terms can be found Clause 1.5](#)

Acid Sulfate Soils Map means a map in an environmental planning instrument that identifies land containing acid sulfate soil.

ancillary development, in Parts 1, 2, 3A and 4, means any of the following that are not exempt development under this Policy –

- (a) access ramp,
- (b) awning, blind or canopy,
- (c) balcony, deck, patio, pergola, terrace or verandah that is attached to a dwelling house,
- (d) basement,
- (e) carport that is attached to a dwelling house,
- (f) detached studio,
- (g) driveway, hard stand space, pathway or paving,
- (h) fence or screen,
- (i) garage that is attached to a dwelling house,
- (j) outbuilding,
- (k) rainwater tank that is attached to a dwelling house,
- (l) retaining wall,
- (m) swimming pool or spa pool and child-resistant barrier.

ANEF contour, for an airport, means a noise exposure contour shown as an ANEF contour on any Noise Exposure Forecast Contour Map for that airport prepared by the Department of the Commonwealth responsible for airports.

articulation zone means an area of a lot forward of the building line within which building elements are permitted to be located,

attached, in relation to a building or structure that is complying development, means not more than 900mm from another building or structure.

attached development means any of the following, if it is situated not more than 900mm from a building that is residential accommodation to which it relates and is not exempt development for the purposes of this Policy –

- (a) access ramp,
- (b) awning, blind or canopy,
- (c) balcony, deck, patio, pergola, terrace or verandah,
- (d) basement,
- (e) cabana, cubby house, fernery, garden shed, gazebo or greenhouse,
- (f) carport,
- (g) driveway,
- (h) garage or hard stand space,
- (i) pathway or paving,
- (j) rainwater tank,
- (k) retaining wall,
- (l) shed.

battle-axe lot means a lot that has access to a road by an access laneway.

boundary wall means a wall that has a setback of 150mm or less from the side or rear boundary of a lot.

building line means the line of the existing or proposed external wall of a building (other than any ancillary development, attached development or detached development) closest to the property boundary adjacent to –

- (a) the primary road of the lot, or
- (b) in the case of a battle-axe lot, the rear boundary of the dwelling house on the lot in front of the battle-axe lot, or
- (c) any other stated boundary of the lot.

bush fire attack level-40 (BAL-40) has the same meaning as it has in AS 3959:2018, Construction of buildings in bushfire-prone areas.

carport means a roofed structure for the shelter of motor vehicles that has 2 or more sides open and not less than one-third of its perimeter open.

class, in relation to a building or part of a building, has the same meaning as in the *Environmental Planning and Assessment Regulation 2000*.

common wall means a wall shared between 2 properties.

corner lot means a lot that has 2 contiguous boundaries with a road or roads (other than a lane) that intersect at an angle of 135 degrees or less (whether or not the lot has any other boundaries with a road).

council means the council of a local government area and, in relation to a particular development, means the council of the local government area in which the development will be carried out.

detached, in relation to a building or structure that is complying development, means more than 900mm from another building or structure.

detached development means any of the following, if it is situated more than 900mm from a building that is residential accommodation to which it relates and is not exempt development under this Policy –

- (a) access ramp,
- (b) awning, blind or canopy,
- (c) deck, patio, pergola, terrace or verandah,
- (d) cabana, cubby house, fernery, garden shed, gazebo or greenhouse,
- (e) carport,
- (f) detached studio,
- (g) driveway, hard stand space,
- (h) garage or hard stand space,
- (i) pathway or paving,
- (j) rainwater tank (above ground),
- (k) retaining wall,
- (l) screen,
- (m) shade structure,
- (n) shed,

and any fence, swimming pool or spa pool and child-resistant barrier that is not exempt development under this Policy.

detached studio means a habitable building that is used for purposes ancillary to a dwelling house such as a home office, entertainment area, art studio or guest room and –

- (a) is established in conjunction with a dwelling house, and
- (b) is on the same lot of land as the dwelling house, and
- (c) is separate from the dwelling house, and
- (d) is not used as a separate dwelling house, and
- (e) does not contain any cooking facilities

draft heritage conservation area means an area of land identified as a heritage conservation area or place of Aboriginal heritage significance in a local environmental plan that has been subject to community consultation, other than an area that was consulted on before 1 March 2006 but has not been included in a plan before 27 February 2009.

draft heritage item means a building, work, archeological site, tree, place or aboriginal object identified as a heritage item in a local environmental plan that has been subject to community consultation, other than an item that was consulted on before 1 March 2006 but has not been included in a plan before 27 February 2009.

dwelling house means a building containing one dwelling, an attached dwelling or a semi-detached dwelling, but does not include any part of the building that is ancillary development, attached development, detached development or exempt development under this Policy.

environmentally sensitive area means any of the following –

- (a) the coastal waters of the State,
- (b) a coastal lake identified in Schedule 1 to *State Environmental Planning Policy (Coastal Management) 2018*,
- (c) land identified as “coastal wetlands” or “littoral rainforest” on the Coastal Wetlands and Littoral Rainforests Area Map (within the meaning of *State Environmental Planning Policy (Coastal Management) 2018*),
- (d) land reserved as an aquatic reserve under the *Fisheries Management Act 1994* or as a marine park under the *Marine Parks Act 1997*,
- (e) land within a wetland of international significance declared under the Ramsar Convention on Wetlands or within a World heritage area declared under the World Heritage Convention,
- (f) land within 100m of land to which paragraph (c), (d) or (e) applies,
- (g) land identified in this or any other environmental planning instrument as being of high Aboriginal cultural significance or high biodiversity significance,
- (h) land reserved under the *National Parks and Wildlife Act 1974* or land to which Part 11 of that Act applies,
- (i) land reserved or dedicated under the *Crown Land Management Act 2016* for the preservation of flora, fauna, geological formations or for other environmental protection purposes,
- (j) land identified as being critical habitat under the *Threatened Species Conservation Act 1995* or Part 7A of the *Fisheries Management Act 1994*.

flood control lot means a lot to which flood related development controls apply in respect of development for the purposes of industrial buildings, commercial premises, dwelling houses, dual occupancies, multi dwelling housing or residential flat buildings (other than development for the purposes of group homes or seniors housing)

floor area, for a balcony, deck, patio, pergola, terrace or verandah means the area measured at the floor level, within the outer face of –

- (a) the external walls if the balcony, deck, patio, pergola, terrace or verandah is enclosed, or
- (b) the balustrade or other safety barrier if the balcony, deck, patio, pergola, terrace or verandah, is not enclosed.

floor area, for a dwelling house means the sum of the areas of each storey of the dwelling house and any carport, garage, balcony, deck, patio, pergola, terrace or verandah, measured at a height of 1.4m above each floor level, that is within the outer face of –

- (a) the external walls of the dwelling house, and
 - (b) the walls of the carport, garage, balcony, deck, patio, pergola, terrace or verandah,
- but does not include any of the following –
- (a) any part of an awning, blind or canopy that is outside the outer wall of a building,
 - (b) the eaves,
 - (c) a lift shaft,
 - (d) a stairway,
 - (e) a void above a lower storey.

floor area, for an outbuilding means the sum of the areas of each storey of the outbuilding, measured at a height of 1.4m above each floor level, within the outer face of –

- (a) the external walls of the outbuilding if it is enclosed, or
 - (b) the supporting columns or posts of the outbuilding if it is not enclosed,
- but does not include any of the following –
- (c) any part of an awning, blind or canopy that is outside the outer wall of a building,
 - (d) the eaves,
 - (e) a stairway.

grain bunker means a lined area in which grain is stored under a non-structural cover

gross floor area means the sum of the floor area of each floor of a building measured from the internal face of external walls, or from the internal face of walls separating the building from any other building, measured at a height of 1.4m above the floor, and includes habitable rooms in a basement or an attic, but excludes the following –

- (i) any storage area, vehicular access area, loading area, garbage area or services located in a basement,
- (ii) 1 car parking space per dwelling, including access to the parking space, if –
- (iii) the dwelling is not a secondary dwelling, and
- (iv) the excluded area is not more than 18m²,
- (a) any terrace or balcony with outer walls less than 1.4m high,
- (b) voids above a floor at the level of a storey or storey above,
- (c) any common area intended to be used by occupants of the building to access dwellings on higher or lower storeys of the building such as a stairwell or lift shaft.

habitable room means a room used for normal domestic activities, other than a bathroom, laundry, toilet, pantry, walk in wardrobe, hallway, lobby, clothes drying room or other space of a specialised nature that is not occupied frequently or for extended periods.

heritage conservation area means an area of land identified as a heritage conservation area or a place of Aboriginal heritage significance, including any heritage items situated on or within that area, in an environmental planning instrument.

heritage item means a building, work, archaeological site, tree, place or Aboriginal object identified as a heritage item in an environmental planning instrument.

landholding includes one or more lots of land (whether held under the same title, different titles or different kinds of titles) that constitute or are worked as a single property and that are contiguous with one another or are separated from one another only by a road, river, creek or other watercourse.

lane means a public road, with a width greater than 3m but less than 7m, that is used primarily for access to the rear of premises and includes a nightsoil lane.

manor house means a residential flat building containing 3 or 4 dwellings, where –

- (a) each dwelling is attached to another dwelling by a common wall or floor, and
- (b) at least 1 dwelling is partially or wholly located above another dwelling, and
- (c) the building contains no more than 2 storeys (excluding any basement).

multi dwelling housing (terraces) means multi dwelling housing where all dwellings are attached and face, and are generally aligned along, 1 or more public roads.

outbuilding means any of the following class 10a buildings under the Building Code of Australia –

- (a) balcony, deck, patio, pergola, terrace or verandah that is detached from a dwelling house,
- (b) cabana, cubby house, fernery, garden shed, gazebo or greenhouse,
- (c) carport that is detached from a dwelling house,
- (d) farm building,
- (e) garage that is detached from a dwelling house,
- (f) rainwater tank (above ground) that is detached from a dwelling house,
- (g) shade structure that is detached from a dwelling house,
- (h) shed.

parallel road means, in the case of a lot that has boundaries with parallel roads, the road that is not the primary road.

parallel road lot means a lot that has boundaries with 2 parallel roads, not including a lane.

primary road means the road to which the front of a dwelling house, or a main building, on a lot faces or is proposed to face, and includes any road that intersects with that road at an angle of more than 135 degrees and with which the dwelling house or main building has contiguous boundaries.

professional engineer means

a person who

- (a) if legislation is applicable — a registered professional engineer in the relevant discipline who has appropriate experience and competence in the relevant field, or
- (b) if legislation is not applicable
 - (i) a Corporate Member of the Institution of Engineers, Australia, or
 - (ii) eligible to become a Corporate Member of the Institution of Engineers, Australia, and has appropriate experience and competence in the relevant field.

protected tree means a tree that requires a separate permit or development consent for pruning or removal but does not include a tree that may be removed without development consent under this Policy.

secondary road means, in the case of a corner lot that has boundaries with adjacent roads, the road that is not the primary road.

setback means the horizontal distance between the relevant boundary of the lot and the building line.

setback area means the area between the building line and the relevant boundary of the

Standard Instrument means the standard local environmental planning instrument prescribed by the Standard Instrument (Local Environmental Plans) Order 2006.

standard lot means a lot that is not a battle-axe lot, a corner lot or a parallel road lot.

the Act means the Environmental Planning and Assessment Act 1979.

working day means a day other than a Saturday, Sunday or public holiday



planning.nsw.gov.au